

# ROYAL ENFIELD OWNER'S MANUAL

---

---



EUROPE & UK



---

---

## FOREWORD

Congratulations. You now own a piece of history!

The Royal Enfield Interceptor is our heritage-inspired machine, built for the modern, intrepid traveller.

With your new machine, we mark the return of one of Royal Enfield's most loved classic motorcycles - the Interceptor.

Harking back to a time when all that mattered was that the California sun was out and the surf was up, this motorcycle retains the charm that made it legendary.

Designed to be simple and robust with solid and precise engineering, the Interceptor has been built to be your faithful companion on rides and adventures, big and small. Powered by our brand-new air-cooled 648cc twin cylinder engine and robust twin cradle chassis developed at our state-of-the-art technology centre in the United Kingdom, we hope you enjoy riding your motorcycle as much as we enjoyed building it for you.

This manual is your friend, philosopher and guide when it comes to taking care of your motorcycle. In the pages that follow, you will find ways of looking after your machine so that it remains a reliable partner in your travels and exploration for decades to come.

Please do avail of all the services at your nearest Authorised Service Centre to make sure that your motorcycle gets the right treatment which it so deserves. Please also read through the terms and conditions of warranty and other useful information in this manual before riding off into the sunshine.

To know more about Royal Enfield, our products, and other news, go to [www.royalenfield.com](http://www.royalenfield.com) <http://www.royalenfield.com>

-Keep riding pure.

---

---

---

## NOTICE

---

All information in this manual is based on the latest product information available at the time of publication. Due to continuous improvements, there may be differences between the information provided in this manual and information related to your motorcycle.

Always consult an authorized Royal Enfield dealer for the latest specifications, features etc. Royal Enfield reserves the right to make production changes at any time without prior notice and without incurring any obligation to make the same or similar changes to a motorcycle previously built or sold.

Please take care while disassembling and assembling the seats and sheet metal parts, as any sharp edges will lead to injuries. All images shown are for reference to explain and need not to be exactly the same on the model you own. Accessories and features may not be part of standard equipment. Technical specifications are subject to change without prior notice at the sole discretion of Royal Enfield.

“© Copyright 2023 Royal Enfield (A unit of Eicher Motors Ltd.). All Rights Reserved. No part of this manual shall be copied, distributed or otherwise dealt without the express permission in writing from Royal Enfield”.

To avail further details on the products Repair and Maintenance Informations at <https://serviceinfo.royalenfield.com> through a paid subscription.

### DISCLAIMER

1. Do not polish matt finished paint surface in your motorcycle as it will increase the gloss level.
2. Wash the painted parts only with plain water and do not use any strong solvents cleaning agents or detergents.
3. Scratches, if happens on the matt finish parts cannot be touched up and corrected / removed.
4. Warranty is not applicable for any matt finished painted parts of the motorcycle.

### NOTE

- This motorcycle meets the Euro 5+ norms.

Part No.RAM00723/A /16th December 2025/

---

# CONTENTS

---

Safety definitions .....	4	Minor maintenance tips .....	55
Personal and motorcycle information .....	5	Long trip precautions .....	86
Safe riding tips / Guidelines .....	6	Rear suspension setting .....	87
Rules of the road .....	10	Washing procedure .....	89
Accessories and luggage .....	12	Storage precautions .....	92
Technical specifications .....	14	Troubleshooting .....	93
Recommended lubricants .....	19	Environment care .....	95
Motorcycle identification numbers .....	20	Periodical maintenance .....	96
Location of key parts .....	21	General warranty terms and conditions .....	102
Operation of controls .....	24	Borderless warranty terms and conditions .....	108
Warning indications and safety systems .....	41	Customers responsibility / Limitation of liability .....	110
Pre-operational checks .....	46	Emission warranty .....	111
Running in period .....	47	Evaporative emission control system warranty .....	116
Starting .....	48	Radio type approval (If fitted) .....	118
Gear shifting, riding and stopping .....	51	Service / Maintenance record .....	119
Parking .....	53	Wiring diagram .....	120
Tools kit .....	54		

---

## **SAFETY DEFINITIONS**

---

The information given under the titles: Warning, Caution and Note are for your safety and for the care and safety to your motorcycle and others. Please read these carefully and if disregarded may result in injury to yourself or others and damages to the motorcycle.



---

### **WARNING**

---

Indicates a potentially hazardous situation. Disregarding this message may result in injury to rider or other persons.

---

### **CAUTION**

---

This message, if disregarded, may result in damage to the motorcycle.

---

### **NOTE**

---

Indicates important and useful messages for better understanding.

## PERSONAL AND MOTOR CYCLE INFORMATION

Name																					
Door No. / Street																					
Locality / Town																					
City											Country										
Contact No.	Res :										Off :										
	Mobile :										Email :										
Licence No.											Valid till :										
Model											Color :										
Engine No.																					
VIN. No.																					
Tyre make	Front :										Rear :										
Tyre Nos.	Front :										Rear :										
Battery make											Battery No.										
Sold by																					
Date of sale																					

---

## SAFE RIDING TIPS / GUIDELINES

---

- Before operating your new motorcycle, we request you to carefully read and follow the operating and maintenance instructions detailed in this manual for the safety of your own, your motorcycle and also that of others.
- Know and adhere to the rules of the road with respect to your driving country.
- Before starting the motorcycle, check for proper operation of brakes, clutch, gear shifter, handle bar controls, tyre pressures, fuel and oil levels, etc.
- Use only genuine Royal Enfield spare parts and approved accessories. Use of other manufacturer's parts may affect the performance of your motorcycle and render the motorcycle void of warranty. Visit your Royal Enfield Authorised Service Centre for details.
- Whenever refueling your motorcycle, please exercise utmost caution and carefully observe the following guidelines.
  - ★ Refuel in a well ventilated area with the engine turned OFF condition.
  - ★ Open the fuel filler cap slowly.
  - ★ Switch OFF mobile phones and other hand held electronic devices.
  - ★ Do not smoke and please ensure that there are no open flames or sparks near the motorcycle, when refueling or servicing the fuel system.
  - ★ Please fill fuel till the bottom of anti splash plate, so as to leave sufficient air space in the fuel tank to allow for fuel expansion.



### WARNING

---

- Royal Enfield cautions you against the use of certain nonstandard parts such as aftermarket and custom made extended front forks or suspensions, which may adversely affect performance and handling. Removing or altering original parts may adversely affect performance and could result in accident.

---

## SAFE RIDING TIPS / GUIDELINES

---

- A new motorcycle must be operated according to the specified running in period. See running-in-period mentioned in respective section.
- Operate motorcycle only at moderate speeds and out of traffic until you have become thoroughly familiar with its operation and handling characteristics under all conditions.
- DO NOT exceed the legal speed limit or ride too fast for existing conditions. Always reduce speed when poor riding conditions exist. High speed increases the influence of any other condition affecting stability and increases the possibility of loss of control.

---

### NOTE

---

If you are an inexperienced rider we recommend that you obtain formal training on correct motorcycle riding techniques and become thoroughly familiar with the operation of your motorcycle. New riders should gain experience under various conditions while driving at moderate speeds.

Pay strict attention to road surfaces and wind conditions. Any motorcycle may be subject to the following upsetting forces:

- ★ Wind blasts from passing vehicles.
- ★ Rough or uneven road surfaces.
- ★ Slippery road surfaces.

These forces may affect the handling characteristics of your motorcycle. If this happens, reduce speed of the motorcycle to a controlled condition. Do not apply brake abruptly.

- Operate your motorcycle defensively. Remember that a motorcycle does not afford the same protection as an automobile in an accident. One of the most common accident situations occurs when the rider / driver of the other motorcycle / vehicle fails to see or recognise a motorcycle and turns into the oncoming motorcyclist.
- Wear an approved helmet, clothing and footwear suited for riding a motorcycle. Bright / light colours are best for greater visibility in traffic, especially at night. Avoid loose, flowing garments and scarves.

---

## SAFE RIDING TIPS / GUIDELINES

---

- When carrying a pillion rider, it is your responsibility to instruct them on proper riding procedures.
  - Do not allow other individuals, under any circumstances, to operate your motorcycle unless you know they are experienced, licensed riders and are thoroughly familiar with the operating conditions of your motorcycle.
- 
-  **WARNING**
- 
- Regularly inspect shock absorbers and front forks and look for leaks. Replace worn out parts. Worn out parts can adversely affect stability and handling.
  - Exhaust gas contains poisonous carbon monoxide and chemicals, known to cause cancer, birth defects or reproductive defects, durability / longevity operation of your motorcycle.
  - For your personal welfare, all the listed service and maintenance recommendations should be performed. Lack of regular maintenance at the suggested intervals may affect the safe/durability/longevity operation of your motorcycle.
  - Avoid any contact with the exhaust system when hot. Wear clothing that will completely cover the legs while riding. The exhaust system gets very hot when the engine is running and remains too hot to touch, even after the engine is turned OFF. Failure to wear proper or protective clothing could result in serious injury.
  - Motorcycle batteries contain lead, acids and chemicals known to cause cancer, birth defects or other reproductive harm. Exercise extreme caution while handling a battery, wash hands thoroughly whenever a battery is handled.

---

## SAFE RIDING TIPS / GUIDELINES

---



### WARNING

---

- Consult your Royal Enfield Authorised Service Centre regarding any questions or problems that occur in the operation of your motorcycle. Failure to do so may aggravate an initial problem, cause costly repairs and jeopardize your personal safety.
- Do not tow a motorcycle. The steering and handling of the towed motorcycle will be impaired due to the force of the towline. If a motorcycle must be transported, use a truck or a trailer.
- Do not pull a trailer behind a motorcycle. Towing a trailer may cause reduced braking efficiency, tyre overloading and unstable handling, as it may cause loss of control of the motorcycle in the front, leading to an accident.

---

## RULES OF THE ROAD

---

- Be sure your number plate is installed in the position specified by law and is clearly visible at all times.
- Ride at a safe speed that is consistent with the type of road surface you are on. Pay strict attention while riding on the following surfaces :
  - ★ Dusty
  - ★ Oily
  - ★ Icy
  - ★ Wet
  - ★ Sand
- Watch for loose debris, such as leaves, slippery substances or gravel that can hamper the stability of your motorcycle.
- Keep to the correct side of the road center line when meeting oncoming vehicles.
- Actuate your turn signals and exercise caution when passing other vehicles going in the same direction. Never try to pass another vehicle going in the same

direction at street intersections, on curves, or when going up/or down a hill.

- At street intersection give the right-of-way to the motorcycle on your left or right. Do not presume you have the right-of-way.
- Adhere to the rules of the road with respect to your country when preparing to stop, turn or pass. While turning either right or left, watch for pedestrians, animals, as well as other vehicles.
- All traffic signs, including manual controls at intersections, should be obeyed promptly. SLOW DOWN at traffic signs near schools and CAUTION signs at railroad crossings.
- When intending to turn, signal at least 100 feet (30.5 meters) before reaching the turning. Be close to the center line (unless local rules require otherwise), slow down and then turn carefully.

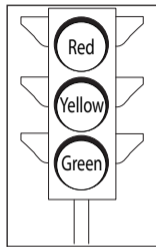

---

## RULES OF THE ROAD

---

- Never jump a traffic light. When a change is imminent from GO to STOP (or vice versa) at intersections, slow down and wait for the light to change to green. Never run through a yellow or red traffic light.
- DO NOT leave the curb or parking area without signaling. Be sure your way is clear to enter moving traffic. A moving line of traffic always has the right-of-way.
- When parking the motorcycle, park on a firm and flat surface to prevent it from falling over.
- Protect your motorcycle against theft. After parking your motorcycle, ensure that the steering head is locked and then remove the ignition key.

---

### SIDE VIEW MIRRORS

---

Your motorcycle is equipped with convex mirrors and have a curved surface. This type of mirror is designed to give a much wider view of the rear than a normal flat mirror. However, vehicles and other objects seen in this type of mirror will look smaller and farther away than when seen in a flat mirror.

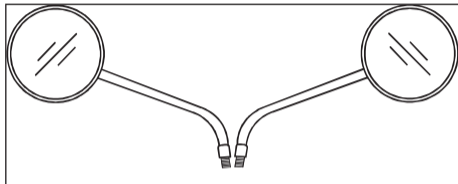

Use care when judging the size or distance of vehicles / objects seen in these mirrors. Use the tool available in tool kit to loosen and adjust the side mirrors.

---

### NOTE

---

To establish the relative distance of vehicles / objects behind your motorcycle through the mirrors, adjust each mirror in such a way, that a small portion of your shoulder is visible and a large portion behind your motorcycle is seen clearly with reference to your riding posture.

---

## ACCESSORIES AND LUGGAGE

---

Royal Enfield offers a range of Genuine Motorcycle Accessories that have been fully approved and extensively tested alongside the motorcycle.

Therefore, the rider must be responsible for safe operation of the motorcycle when installing accessories or carrying additional weight.

Please adhere to the following guidelines when carrying a pillion, luggage or when fitting any accessories.

- Do not exceed 110 km/h (68.3 mph) when riding solo, carrying a pillion or payload on an accessory equipped motorcycle.
- Keep luggage weight concentrated close to the motorcycle and as low as possible; this minimizes sudden shift in the motorcycle's center of gravity.
- Distribute weight evenly on both sides of the motorcycle.
- Do not load bulky items behind the rider or add weight to the handlebars or front forks.

- Re-check the luggage periodically to ensure it is secured and will not shift while riding. Accessories mounted loosely may affect the riding of the motorcycle and affect the handling and stability of the motorcycle.
- Large surfaces such as fairings, windshield, backrest and luggage racks can adversely affect handling of the motorcycle. Use Royal Enfield Genuine Motorcycle Accessories which are model specific and follow installation procedure.



### WARNING

---

- The total weight of the rider, passenger, accessories and luggage must not exceed the gross vehicle weight which is stated in the specifications section.
- Do not load weight or install accessories incorrectly on the motorcycle.
- Doing so may affect the motorcycle's stability, handling characteristics and safe operation and could result in an accident causing serious injury or loss of life.

---

## ACCESSORIES AND LUGGAGE

---



### WARNING

---

- Royal Enfield offers a range of Genuine Motorcycle Accessories that have been fully approved and extensively tested alongside the motorcycle.
- Royal Enfield cautions you against use of nonstandard parts such as aftermarket and custom made extended front forks which may adversely affect the performance and handling of the motorcycle. Removing or altering original parts may adversely affect the performance of the motorcycle, causing an accident, which could result in serious injury or loss of life.
- Do not ignore model / design specifications. Doing so constitutes both motorcycle and accessories misuse which may adversely affect the handling and performance of the motorcycle causing an accident, which could result in serious injury or loss of life.

---

## TECHNICAL SPECIFICATIONS

---

### ENGINE

---

Engine type ..... Inline twin cylinder, 4 stroke, SOHC

Bore ..... 78 mm

Stroke ..... 67.8 mm

Engine capacity..... 647.95 cc

Compression ratio.... 9.5:1

Max power ..... 34.9 kW @ 7150 rpm

Max torque ..... 52.3 Nm @ 5150 rpm

Idle rpm..... 1200 ± 100 rpm

Starting ..... Electric start

Air filter element..... Paper element

Lubrication..... Forced lubrication, Wet sump with pump driven oil delivery

Gear box ..... 6 Speed constant mesh

Fuel supply ..... Fuel injection

Cooling ..... Air cooling

---

### IGNITION SYSTEM

---

Ignition ..... Digital spark ignition

Ignition advanced..... 11.25° BTDC

Spark plug..... BOSCH UR5CC

Spark plug gap..... 0.7 mm to 0.8 mm

---

# TECHNICAL SPECIFICATIONS

---

## TRANSMISSION

---

Clutch.....	Wet multi plate
Primary drive.....	Gear
Primary ratio .....	2.051:1
Gear box.....	6 Speed, Constant mesh
Gear ratio .....	1 <sup>st</sup> 2.615:1
	2 <sup>nd</sup> 1.813:1
	3 <sup>rd</sup> 1.429:1
	4 <sup>th</sup> 1.190:1
	5 <sup>th</sup> 1.040:1
	6 <sup>th</sup> 0.962:1
Secondary drive.....	Sprockets and chain (5/8 Pitch)
Secondary ratio.....	2.533:1

## CHASSIS

---

Frame ..... Steel tubular, double cradle frame

### Suspension

Front..... 41 mm front fork, 110 mm travel

Rear ..... Single coil-over shocks, 88 mm travel

### Brakes

Brake System..... Dual channel ABS

Front ..... 320 mm disc, ABS

Rear ..... 240 mm disc, ABS

Type of wheels	Solo	With pillion
Front	32 psi	32 psi
Rear	36 psi	39 psi

# TECHNICAL SPECIFICATIONS

Type of wheel	Tyre Size
Front Tyre	100/90-18 M/C 56H CEAT ZOOM CRUZ F
	100/90-18 M/C 56H PIRELLI PHANTOM SPORTS
Rear Tyre	130/70-18 M/C 63 H CEAT ZOOM CRUZ
	130/70-18 M/C 63 H PIRELLI PHANTOM SPORTS

## NOTE

- On tube type rim, fit the tyre with a tube.
- On tubeless type rim, use tubeless type tyre only.

Steering lock.....	Combination lock
Fuel type .....	E5/E10 Unleaded gasoline
Induction .....	Fuel injected
Fuel tank capacity .....	13.7* L
Low fuel warning .....	2.9* L
Dead stock .....	0.75* L

\* The above values are approximate and the actual capacity will vary with each fuel tank.

## DISCLAIMER

- The Model fitted with tubeless tire is provided with an inner tube.
- Failure to use an inner tube in a spoked wheel will cause deflation of the tire resulting in loss of motorcycle control.
- The approved tires marked with "Tubeless" are suitable for use with inner tube on spoke wheels.
- The approved tires marked with "Tubeless" are suitable for use without inner tube on alloy wheel.

---

# TECHNICAL SPECIFICATIONS

---

## ELECTRICALS

---

System .....	12V - DC
Generation.....	Alternator
Alternator output.....	156 W @ 1100 rpm
Battery.....	12V - 12 Ah VRLA
Head lamp.....	FPL 1.55 W LED, low beam 12.1 W, high beam + low beam 14.2 W, low beam + high beam + FPL 15.7 W
Brake/Tail lamp.....	12 V, P21/5 W (Halogen)
Turn signal.....	12 V, 10 W
Instrument cluster.....	Digital Instrument Cluster with LCD
Horn.....	12 V/2.5 A (Dual tone)
Starter motor.....	12 V, 0.8 kW

Charger port..... USB 2.0 - 5 V 2 A output



## WARNING

---

- Using bulbs/electrical gadgets other than specified rating will lead to overloading/erratic behaviour/premature failure of electrical system.
- Modifications or fitments which are not approved by Royal Enfield, will seriously affect the performance of the vehicle and will render the warranty void.

## DIMENSIONS

---

Rake .....	24 degrees
Front wheel rim size (Alloy & Spokes wheel) .....	18 M/C x MT 2.50
Rear wheel rim size (Alloy & Spokes wheel).....	18 M/C x MT 3.50
Length.....	2119 mm

---

## TECHNICAL SPECIFICATIONS

---

Width.....	835 mm
Height .....	1120 mm
Wheel base.....	1398 mm
Ground clearance.....	174 mm

---

### WEIGHTS

---

Kerb weight (90% fuel and oil).....	217 kg
Gross vehicle weight .....	400 kg

---

### NOTE

---

- Values / dimensions given above only for your guidance.
- In view of continuous improvements being done on our products, the specifications could change without prior notice.

---

## RECOMMENDED LUBRICANTS

---

ENGINE OIL		FRONT FORK OIL	BRAKE FLUID	
Grade	10W-50 to API SL (or higher) JASO MA2, such as ELF MOTO4 TECH 10W 50 (Fully synthetic)		DOT 4*	
Capacity	1 <sup>st</sup> dry fill : 3.9 L	Routine oil change : 3.1 L	473 ml / Fork	Front : 50 ml Rear : 100 ml

---

### CAUTION

---

Use of wrong oil grade will reduce the life of the moving parts and seriously affect performance.

\* DO NOT Mix DOT 4 or other brake fluids together.

---

### NOTE

---

1. Recommendation subject to change without notice.
2. The above values are approximate and the actual capacity will vary.

---

# MOTORCYCLE IDENTIFICATION NUMBERS

---

## FRAME NUMBER

Punched on steering head tube right side.

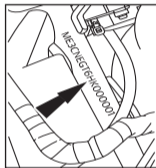

## VIN INFORMATION PLATE

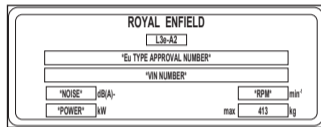

## ENGINE NUMBER

The engine number is punched on the left hand side crankcase. It is the means of identification of the engine and its production details. Please do not tamper with the engine number as it is prohibited by law.

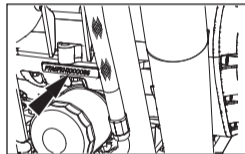

---

## CAUTION

---

It is illegal to tamper with or alter the VIN/Engine numbers of the motorcycle as it will not only be against the law but will render the vehicle registration and warranty void.

---

## LOCATION OF KEY PARTS

---

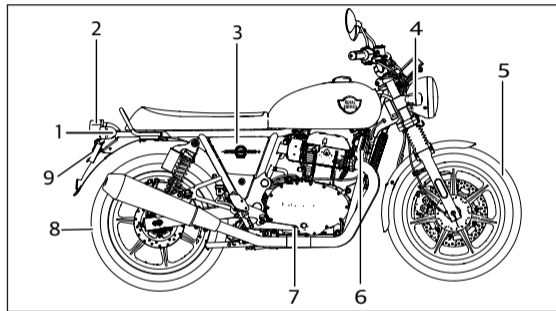

1. Right trafficator rear
2. Tail lamp
3. Right side panel
4. Right trafficator front
5. Front wheel\*
6. Horn
7. Rear brake pedal
8. Rear wheel\*
9. License plate illuminator

### DISCLAIMER

\* The part displayed above are for reference purpose only. This will vary from the parts chosen using motorcycle configurator.

---

## LOCATION OF KEY PARTS

---

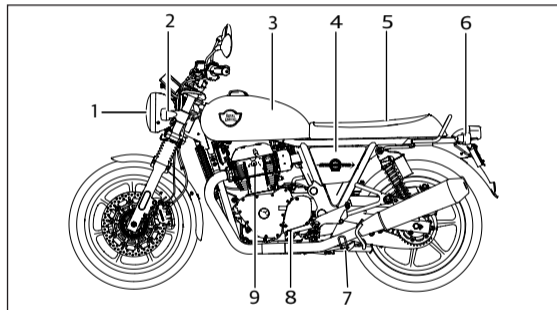

1. Head lamp
2. Left trafficator front
3. Fuel tank
4. Left side panel / battery cover
5. Seat
6. Left trafficator rear
7. Side stand
8. Gear change pedal
9. Spark plug

---

### NOTE

The center stand is not OE fitment in Interceptor 650 model.

---

## LOCATION OF KEY PARTS

---

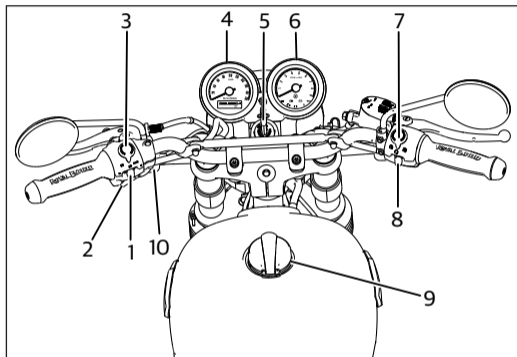

1. Turn signal switch
2. Horn button
3. High/Low beam/Flashing switch
4. Speedometer
5. Ignition key
6. Tachometer
7. Ignition/Engine kill switch
8. Hazard switch
9. Fuel tank cap
10. USB charger port

---

### NOTE

The tripper is not OE fitment in Interceptor 650 model.

## OPERATION OF CONTROLS

### IGNITION SWITCH

⊗ "OFF"

○ "ON"

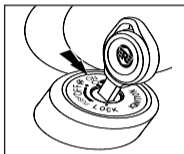

### NOTE

- Key is common for ignition, petrol tank lock, steering lock and right side panel.
- Key can be removed from fuel tank, right side panel only in locked position from the key slots.
- Key can be removed only if ignition is in OFF or steering is locked.



### WARNING

- Do not switch OFF ignition while riding the motorcycle.
- Doing so can cause a potential accident, resulting in serious injury to both rider and other road users, besides causing severe damage to the motorcycle.

### STEERING LOCK

- Turn the handle bar to extreme left position.
- Push the key inside at "OFF" position, press and further turn to anticlockwise direction to lock the steering and remove the key.
- Turn the key in the clockwise direction to unlock the steering.

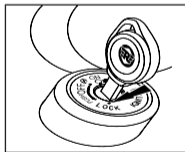

# OPERATION OF CONTROLS

## FUEL TANK CAP

- Lift key flap on fuel tank cap and insert key.
- Turn key clockwise to open.
- Press cap to lock with key in position.
- Remove key from cap and close flap.

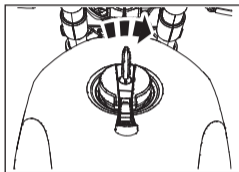

## WARNING

- DO NOT over fill the fuel tank.
- Fill fuel only till the bottom of anti splash plate.
- Over filling may result in fuel entering the EVAP canister and may damage the evaporative emission system.

## CAUTION

- Gasoline vapour is highly explosive. Please ensure there are no open flames or sparks nearby while refueling and fill fuel only in a well ventilated area.
- Please ensure gasoline does not spill on painted surfaces. In case fuel spills over the painted surfaces wipe it off immediately as it may leave a permanent stain.
- Do not smoke while refueling or when fuel tank cap is open.

## FUEL FILLING LEVEL

1. Fuel filler collar
2. Anti splash plate
3. Maximum fuel level

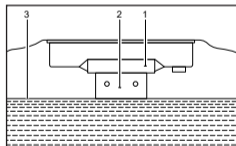

## OPERATION OF CONTROLS

### IGNITION/ENGINE KILL SWITCH

⊗ Engine "OFF"

○ Engine "ON"

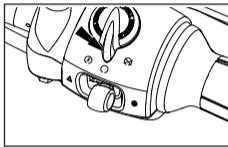

### CAUTION

- Turn OFF ignition switch when engine is not running. Failure to do so will discharge the battery due to the headlamp being continuously "ON".

### E-START SWITCH

- ⚡ Push and hold electric start switch until engine starts for a maximum of 5 seconds.

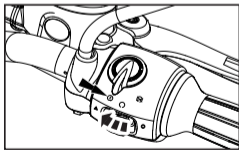

### CAUTION

- In case of prolonged stoppage of vehicle, please turn off ignition key to avoid discharge of battery.

### HAZARD LIGHT SWITCH

⚠ Hazard Light "ON"

● "OFF"

### CAUTION

- Hazard flashing will create a strain on battery. Do not use hazard warning for longer period unless necessary.

Methods to activate hazard flasher :

- Ignition switch ON, slide the hazard control to ON position. Hazard will work unless manual deactivation (OFF).

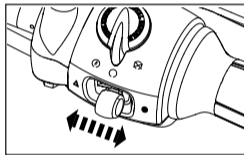

## OPERATION OF CONTROLS

- Ignition switch ON, slide the hazard control to ON position-Hazard will start working - Ignition switch OFF - Hazard will keep working for a duration of 30 minutes - Unless manual deactivation (OFF).
- Hazard flasher cannot be activated in Ignition switch OFF condition.



### WARNING

- Turn signals do not work when the hazard light switch is "ON".
- All the trafficator lamps will flash simultaneously.

### HORN

 Press the horn button to sound horn.

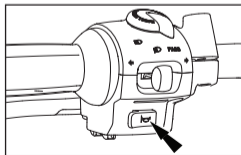

### HIGH BEAM / LOW BEAM SWITCH

- When the headlamp is in "ON" condition "High / Low beam" will be selected by toggling the switch. High beam indicator lamp located in instrument cluster will glow when high beam is selected.

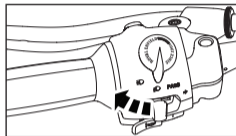

 High beam

 Low beam

### FLASH SWITCH

Press the switch for flashing switch.

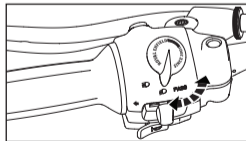

## OPERATION OF CONTROLS

### TURN SIGNAL SWITCH

- ⇐ Left turn signal "ON"
- ↑ "OFF" (Push to cancel)
- ⇒ Right turn signal "ON"

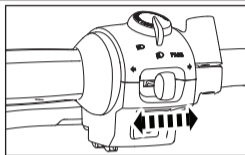

Push the button from "OFF" position to either left or right before turning as needed. To cancel the turn signal lights, push the switch after it has returned to the center position.

### SIDE PANEL LEFT

- To access the left side panel remove the seat and retaining screw, pull and disengage the side panel from locator and gently remove the side panel.



### SIDE PANEL RIGHT

- Turn key clockwise to unlock the side panel.
- Pull the side panel along with key to gently remove the side panel.

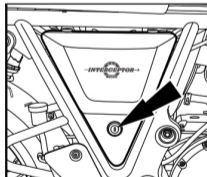

---

# OPERATION OF CONTROLS

---

## INSTRUMENT CLUSTER

---

This instrument cluster consists of the following:

1. Speedometer
2. Odometer
3. Trip Meter 'A' and 'B'
4. Fuel Level Indicator
5. Selection Button
6. Tachometer
7. Turn Signal Indicator
8. Engine Malfunction Indicator
9. High beam Indicator
10. Battery Low Voltage Indicator
11. ABS Indicator
12. Neutral Indicator
13. Low Oil Pressure Indicator

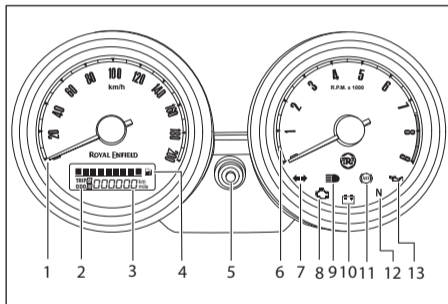

## OPERATION OF CONTROLS

### SPEEDOMETER

The speedometer indicates the speed at which motorcycle is travelling and has both km/mph calibration.

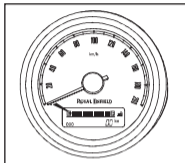

### ODOMETER

The default display in the odometer is the total km/mph, the motorcycle has covered.



### NOTE

The last selection mode will be displayed whenever ignition is switched "ON".

### ⚠ WARNING

It is illegal to tamper with the odometer display or reset the total km, the motorcycle has covered. It is illegal to ride the motorcycle after disconnecting the speed sensor of the motorcycle.

30 | Royal Enfield Interceptor 650

### SELECTOR BUTTON

The selector knob will help to select between odometer, Trip 'A' or Trip 'B'.

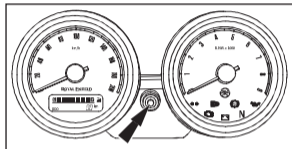

### TRIP METER 'A' AND 'B'

A light push for less than one second on the select button switch will change the display from odometer Trip 'A'. Again another press on the select button switch will change the display from Trip 'A' to Trip 'B'.

### NOTE

- Set the display as Trip 'A' or Trip 'B' as current mode.
- Press the select button for more than 3 seconds.
- Automatically the display will become zero.

# OPERATION OF CONTROLS

## Unit Changeover

- Change the Gear to Neutral mode and do ignition switch OFF.
- Hold the info button and turn the ignition switch to ON.
- Long press the info button to 15 seconds approximately during ignition switch ON.
- ODO reading changes from miles to k.m and Vice versa.

## NOTE

Trip A / Trip B- If it clocks 9999.9 km and ODO- 99999.9 Km it will reset to zero again automatically without notifications.

## WARNING

Do not attempt to change any setting while riding the motorcycle. It may cause loss of control leading to an accident.

## TURN SIGNAL INDICATOR

Indicates that either the left or right indicators are "ON".

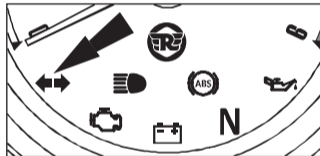

## HIGH BEAM INDICATOR

Indicates that the high beam head lamp is "ON".

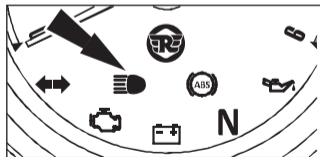

---

## OPERATION OF CONTROLS

---

### ENGINE MALFUNCTION INDICATOR LAMP

---

- A Malfunctioning indicator lamp (MIL) is provided in the tachometer.
- When both the ignition and engine kill switch is in "ON" position and after vehicle is started, the MIL will glow for few seconds and switch "OFF" this indicates that all the functions of Electronic fuel injection (EFI) system is functioning normally. In the event of any malfunction in the EFI system MIL will glow continuously.
- It is recommended to take the motorcycle to a nearest Royal Enfield Authorised Service Centre for a detailed inspection and correction of EFI system.

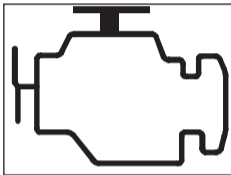

### BATTERY LOW VOLTAGE INDICATOR

---

- When the ignition switch is turned in "ON" position, low voltage indicator symbol will glow. As soon as the engine is started the battery low voltage indicator turns "OFF" automatically.
- In case the battery voltage is below 12 volt and the battery is not charging when the engine is started, the battery low voltage indicator will continue to glow in the instrument cluster.

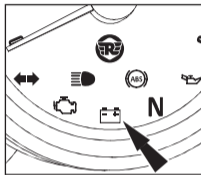

---

### CAUTION

---

- DO NOT ride the motorcycle if the battery low voltage indicator is glowing continuously and please get the charging system checked through an Royal Enfield Authorised Service Centre immediately.

---

## OPERATION OF CONTROLS (If fitted)

---

### TRIPPER

---

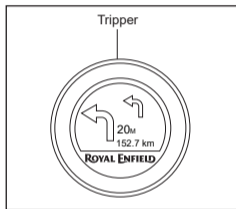

- Tripper is being provided to have turn by turn navigation on motorcycle to help riders to have a hassle free riding without handling the smartphones. This device works based on bluetooth connectivity with navigation search based on RE Mobile app with the support of Google Maps.

- Device is capable of showing turn by turn navigation on a custom designed round colour TFT with uniquely designed arrow font designed intuitively for ease of riding.
- Background display can be switched between day mode and night mode which can be selected by riders from RE Mobile app.
- Scan the QR Code, to download, Install, register and to know more about the Tripper.



---

## OPERATION OF CONTROLS (If fitted)

---

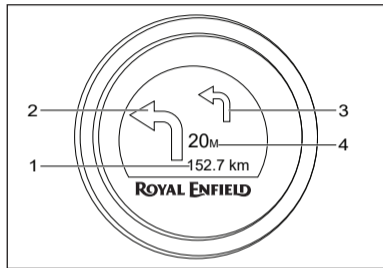

1. Distance to destination or ETA
2. Primary direction or next turn
3. Secondary direction or next to next turn
4. Distance to next turn

### Features:

- Turn by turn navigation with primary turn, secondary turn.
- Distance to next turn, distance to destination or Estimated Time of Arrival (ETA).
- Clock display (in case of no connectivity, no navigation input or after destination is reached).
- User can select day and night mode (through RE Mobile app only).
- Mobile phone low battery indication.

---

### DISCLAIMER :

---

- Tripper unit display may look dull during sun overhead conditions this is normal and due to impact of direct sunlight on the unit customers to refer during other riding conditions.

---

## **OPERATION OF CONTROLS (If fitted)**

---

- Primary direction or next turn; Indicates the next turn to be taken along with the distance.
- Distance to next turn: Shows the distance to next turn.
- Secondary direction or next to next turn: Indicates the next turn to be taken after the primary direction, will be shown only when primary turn is less than 100 m, if there is no turn the display will be blank in this region.
- Distance to destination or ETA: Shows the total distance to destination or Estimated Time of Arrival (based on used selection from RE Mobile app).

### **Smartphones compatible version to use**

#### **RE Mobile app:**

- Compatible with Android and iOS.
- Android Support : Current version (-2).
- iOS support : Current version (-1).
- Connectivity control only through RE Mobile app.

# OPERATION OF CONTROLS (If fitted)

## TRIPPER - DISPLAY FLOW SEQUENCE

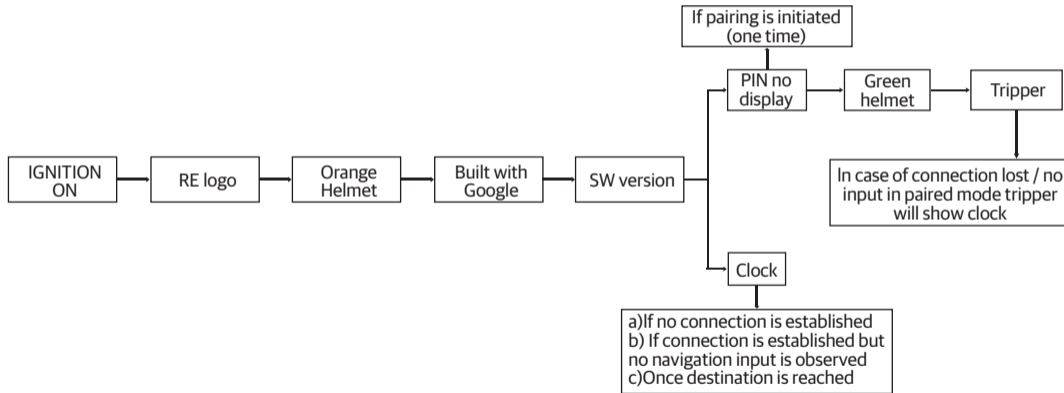

---

## OPERATION OF CONTROLS (If fitted)

---

### NOTE

- After every Ignition "ON" cycle tripper will be in discoverable mode for 120 seconds.
- In case there is no connection established within 120 seconds. Display will enter into clock mode, to reinitiate connection ignition "OFF-ON" cycle to be repeated.
- During navigation mode if there is no input from smartphone for 5 seconds, bluetooth connection will be terminated to avoid power draw and will display clock.
- Bluetooth connection can be terminated by end user also by closing the mobile application.
- For first time pairing user needs to enter the secured pin shown on tripper through RE Mobile app to setup the device, after that auto-pairing will happen if same device is connected.
- Every time the tripper is paired the clock time will sync with mobile time after which it will continue to run with internal clock even in case of disconnection, there will be time difference between time shown on instrument cluster and tripper - customer needs to update cluster clock in line with time shown on tripper as and when required as mentioned in push button management of cluster.
- Do not apply or use gasoline / petrol related fluids for cleaning or wiping on instrument cluster or tripper, as it may result in permanent damage to the same.

---

## OPERATION OF CONTROLS (If fitted)

---

### CAUTION

- Ensure ignition is ON and display is in powered while establishing connection.
- Ensure first time pairing is done in isolated environment to avoid cross connections (one time).
- Day and night mode is user selectable only, will not change over automatically to be selected during night driving to avoid rider distraction.
- Bluetooth connection can be established only through RE Mobile app.
- Ensure bluetooth and location settings are turned always ON before usage.
- Disable battery optimisation settings / low battery cut-off setting of smartphone for navigation to work in low battery mode.
- RE Mobile app works only with Android (Current Version (-2)) and iOS (Current Version (-1)) versions, for other lower versions performance lag can be expected.
- Tripper bluetooth is V4.2. Tripper time display may have a mismatch with actual time displayed in mobile device once the Bluetooth connectivity is lost.
- RE Mobile app works with bluetooth V4.2 and N+1.0, for other lower versions performance lag can be expected.
- Check for network signal strength in case of navigation lag.
- Check for data speed in case of navigation lag, navigation system performance is better in 4G band compared to other lower versions.
- Calibrate mobile phones frequently for more GPS accuracy & location accuracy is dependent on.

---

## OPERATION OF CONTROLS

---

### CHARGER PORT

- Charger port is located on left side handle bar below the clutch lever.

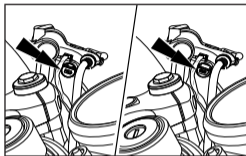

### WARNING

- Recommended not to use in rainy conditions to avoid damages to smart phones and charger, RE shall not be liable for any damage to smart phones.
  - Do not use any other device other than mobile phones, only one mobile shall be charged at one point of time.
- Ensure proper insertion of USB cable, damages due to hard / wrong insertion of cable will not be entertained in warranty.
  - Do not leave the USB port cap partially opened / closed to avoid any short circuit when not in use.
  - Do not insert any metal or conductive materials inside USB charging port which may lead to short circuit.

---

## OPERATION OF CONTROLS

---

### NOTE

---

- Charging port is provided only for charging purpose and no data transfer is enabled.
- Provided is only constant charging mode, fast / dash charging is not provided to be compatible with multiple make mobile phones and cannot be compared with performance of original smart phone chargers.
- Duration of charging can be higher and will vary for different make mobile phones depending on smart phone battery capacity, SOC and smart phone charging circuits.

### CAUTION

---

- Customer to ensure USB port cap is closed and locked properly when not in use, warranty will not be provided if port cap is damaged and not sealed properly.
- If high current draw greater than 2.5 A is observed USB charger will shutdown please check your smart phone battery current ratings before using.
- USB charger will function only when engine is in running condition.
- Use standard approved and high quality USB cables for proper functioning.

## WARNING INDICATIONS AND SAFETY SYSTEMS

Your motorcycle is fitted with the following warning indications and safety systems:

### FUEL LEVEL INDICATOR

- The fuel level indicator indicates the level of fuel in the fuel tank.
- The display bars of the fuel meter fades towards the empty (E) when the fuel level decreases from full tank level (F).
- The last bar of the fuel level indication in the instrument cluster will blink continuously when the fuel is less than 3.1 L.
- Please do not ride the motorcycle with the low fuel indication blinking continuously as it may not only result in the motorcycle running out of fuel, but will also cause serious damage to the fuel pump. Please refuel as soon as the low fuel indication starts blinking.

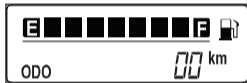

### ANTI-LOCK BRAKING SYSTEM (ABS)

- Anti-Lock Braking System (ABS) will help prevent the brakes from locking the wheels, during sudden application of the brakes at high speeds or at low friction surfaces. This will help the rider to have better traction and control over the motorcycle and prevent the motorcycle from skidding which can cause an accident.
- In the event of a sudden and hard application of the brakes by the rider, the sensors in the braking system will signal the ABS modulator to momentarily and continuously reduce the hydraulic pressure and thereby prevent the brakes from locking the wheels while reducing the speed of the vehicle. This will help the rider to control the motorcycle.

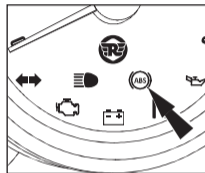

---

## WARNING INDICATIONS AND SAFETY SYSTEMS

---

- An ABS indicator lamp is provided in the cluster (as shown in the adjacent image) to warn the rider in the event of any malfunction of the ABS.
- When the ignition and engine kill switch are switched in "ON" position the ABS sign will glow and remain "ON" till the motorcycle attains a speed of 5 kmph/mph and turns "OFF". This indicates the ABS is functioning properly.
- If the ABS indicator lamp does not switch "OFF" and remains continuously "ON" at higher speeds, it is recommended not to drive the ABS motorcycle. Get the brake system inspected and corrected through a nearest Authorised Royal Enfield Service Centre. Failure to do so can result in a serious injuries and loss of life.
- Please ride carefully and apply brakes cautiously, especially while cornering. ABS cannot estimate the "weight shifts" and momentum of the motorcycle while negotiating a corner and therefore prevent skidding due to loss of traction.
- Please anticipate the stopping distance required for the speed of travel and apply brakes well in advance so as to bring the motorcycle to a safe stop.
- Ensure instrument cluster is in proper functioning as it is an integral part of ABS system.
- Please apply both brakes simultaneously to stop with better traction and control of the motorcycle.
- Failure to adhere to the above can cause an accident resulting in serious injuries and loss of life.

---

### CAUTION (ABS)

---

- ABS is a safety feature to help prevent locking of wheels during panic application of brakes. It is by no means a substitute for good riding practices and anticipatory braking.



---

### WARNING

---

- Always use the approved front / rear tyres and rear sprocket by Royal Enfield to ensure correct ABS operation.

---

## WARNING INDICATIONS AND SAFETY SYSTEMS

---



### WARNING

---

- Do not make any changes to the suspension travel.
- Only use recommended spare parts on the brake system which have been approved by Royal Enfield.
- ABS does not reduce braking distance. In certain circumstances, ABS may result in a longer stopping distance.

---

### CAUTION (ABS)

- Visually inspect for damaged teeth on the front and rear ABS tone rings.
- Inspect for damages and dents on the face of the teeth.
- The teeth edges should be consistent in appearance. In case if a toner ring is found to be damaged or bent, it is recommended to visit nearest dealership for necessary action.

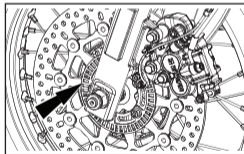

- Inspect for debris at the end of the wheel speed sensors - front & rear, if contamination is observed, it is recommended to clear it suitably or you may visit to nearest dealership for necessary action.

---

### ROLL OVER SENSOR

In the event of motorcycle falling over in either of its sides with the engine running and the gears engaged the roll over sensor will disable fuel systems and switch OFF the engine. This is to prevent any damage to the motorcycle and its rider. To reset the roll over sensor and reactivate the fuel systems.

- Ensure the motorcycle is made upright and is on its center stand.
- Ensure gears are in correct neutral and the neutral lamp is glowing in the instrument console.
- Switch OFF both ignition & stop switches, wait for a few seconds and switch ON the ignition and stop switch again, to start the engine.

## WARNING INDICATIONS AND SAFETY SYSTEMS

### DO'S & DON'TS : (ABS)

DO'S	DON'TS
<ul style="list-style-type: none"><li>■ While starting the engine do check the ABS indicator glows "ON" and turns "OFF" when the vehicle speed exceeds 5 km/h.</li></ul>	<ul style="list-style-type: none"><li>■ DO NOT release the brake lever / pedal when pulsations are felt during hard application of the brakes in an emergency situation. The pulsations only indicate that the ABS is activated.</li></ul>
<ul style="list-style-type: none"><li>■ Please check the brake fluid level in the front and rear brake reservoir and ensure there is no leak in the brake systems.</li></ul>	
<ul style="list-style-type: none"><li>■ Apply both the brakes simultaneously for better efficiency.</li></ul>	<ul style="list-style-type: none"><li>■ DO NOT apply only the front or rear brake as it can lead to inefficient braking.</li></ul>
<ul style="list-style-type: none"><li>■ In the event of the ABS indicator remaining continuously "ON", please take the motorcycle to a nearest Authorised Royal Enfield Service Centre to inspect the brake system.</li></ul>	

---

## **WARNING INDICATIONS AND SAFETY SYSTEMS**

---

### **NEUTRAL INDICATOR**

- This indicator glows when the vehicle is in neutral position.

### **LOW OIL PRESSURE INDICATOR**

- This indicator glows whenever the oil pressure is too low. When the ignition switch is in "ON" position with the engine not running condition the indicator goes off when the engine oil pressure is high enough / normal condition.

### **CAUTION (ABS)**

- When the indicator glows continuously and if the engine speed is above idle, stop the vehicle immediately and get the engine inspected and corrected through a nearest Authorised Royal Enfield Service Centre. Failure to do so can cause engine damage.

### **TACHOMETER**

- This indicates the engine speed in RPM.

---

## PRE - OPERATIONAL CHECKS

---

A careful check on the following aspects must be carried out every time before riding and especially after long periods of storage to determine if any additional maintenance is necessary.

1. Adequate fuel in the tank for the journey planned.
2. Tyres for correct pressure, abrasions or cuts.
3. Ensure chain for proper tension and sufficient lubrication.
4. Brakes, clutch, steering and throttle for proper responsiveness.
5. Smooth operation and free play in front and rear brake levers.
6. Engine oil level.
7. Wheel spokes for proper tightness and damage (It's applicable for spokes wheel model)
8. Headlamp, tail lamp, brake lamp and indicator lamps for proper functioning.
9. Proper functioning of all the warning lamps in the instrument cluster.

10. Brake fluid level is above the "MIN" mark in the master cylinder.
11. Ensure the clutch free play and clutch function.



---

### **WARNING**

---

- For your personal welfare and safety, all the points mentioned above should be performed periodically. Failure to do so may affect safe operation, damage your motorcycle and could result in an accident causing serious injury or loss of life.

---

## RUNNING IN PERIOD

---

The Royal Enfield Motorcycle as you would be experiencing is capable of consistent high speeds. However as with any new motorcycle, a "RUNNING-IN PERIOD" procedure is essential to help in proper "Bedding-In" of the various moving parts in your motorcycle and to achieve optimum performance subsequently.

1. Do not exceed maximum specified pay load.
2. Warm up the engine for a few minutes at idling speed to allow engine oil to lubricate all the moving parts in the engine before riding the motorcycle.
3. Avoid full throttle operation and do not ride at constant throttle continuously. Vary the speed by 10% while riding.
4. Ride at proper speed and avoid sudden accelerations and braking.
5. Avoid riding motorcycle continuously for over an hour, it is recommended to take brief stop.

---

### NOTE

---

The below table indicates the recommended engine speed in rpm for optimum performance of the engine.

Distance Covered	Max. Engine Speed
0 to 500 km (0 to 311 miles)	4000 rpm
501 to 2000 km (311 to 1243 miles)	6000 rpm

## STARTING

- To shift into neutral, move the motorcycle back and forth gently, while simultaneously shifting the gear. Ensure gear is in neutral position and the neutral lamp is glowing in the instrument cluster.

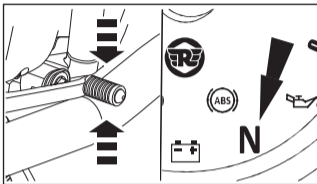

- Turn ignition key to "ON" position and engine kill switch on right hand side handle bar to "RUN" position.

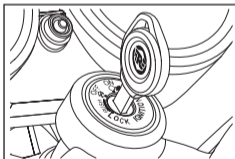

- When both the ignition and engine kill switch is in "ON" position and after the vehicle is started, the MIL will glow for a few seconds and turns "OFF", this indicates that all the function of the electronic fuel injection (EFI) system is functioning normally. In the event of any malfunction in the EFI system the MIL will glow continuously.

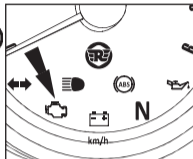

### CAUTION

- In case the malfunction indicator does not turn "OFF", get the motorcycle checked through an Royal Enfield Authorised Service Centre for rectification.

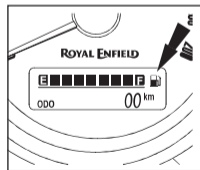

---

## STARTING

---

- Check the fuel level indicator in the cluster for adequate fuel in the fuel tank. In case the last bar is blinking continuously, it indicates low fuel level in the tank. Please re-fuel immediately.

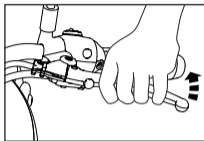

- Disengage clutch by pulling in the clutch lever and hold it in depressed condition.

- Depress and hold electric start switch until engine starts for a maximum of 5 seconds.

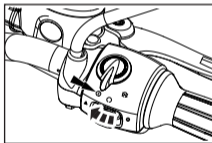

---

### NOTE

---

In case the engine does not start within 5 seconds, release starter switch and wait for about 5 seconds before attempting to start the engine again.

- In case vehicle not starting on multiple continuous attempts, please turn OFF and turn ON ignition switch and then start again.

---

### PRECAUTIONS

---

- Vehicle may start with side stand condition but engine will turn-off when gear is engaged, this side stand cut-off feature is provided for rider safety ensure side stand is retracted before vehicle moving / starting.

---

### CAUTION

---

- If the engine does not start. Do not hold the starter switch in depressed condition for long periods, this will cause the battery to drain below the threshold level of 10 V. Please get the motorcycle checked through an Royal Enfield Authorised Service Centre to identify and correct the reason for not starting.
- Accelerate only after the idling RPM has stabilised and it is consistent.

---

# STARTING

---

## CAUTION

- Never accelerate as soon as the engine starts, especially in cold condition. The engine should be allowed to run in idle rpm for at least 120 seconds for the engine oil to circulate and lubricate all the internal moving parts and for the engine temperature to raise. Failure to adhere to this important information will cause serious damage to the engine internals.

## WARNING

Please exercise extreme care while riding the motorcycle. Failure to do so can result in an accident causing injury to you or to other road users / passerby.

- Ensure gear in neutral position and the neutral lamp is glowing in the speedometer. To shift into neutral, move the motorcycle back and forth gently, while simultaneously shifting the gear.

## CAUTION

Do not attempt to shift gears without moving the motorcycle back and forth as it will damage the gears mechanism.

- Depress and hold the clutch Lever.
- Press starter button and hold till engine starts. Do not release the button before engine starts.
- Do not press the starter button more than 5 seconds after three successive cranking, wait for 15 to 20 seconds the battery to recover.

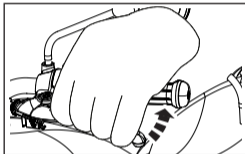

## GEAR SHIFTING, RIDING AND STOPPING

The clutch lever must be fully depressed before attempting a gear shift. Failure to fully depress the clutch lever will cause a rough start or stalling of the engine besides causing damage to transmission parts.

- When the vehicle is in Neutral position, press gear shift lever down with toe to engage 1st gear.

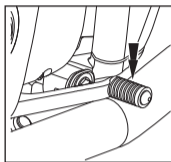

### GEAR SHIFT PATTERN

1 -- N -- 2 -- 3 -- 4 -- 5 -- 6

- It is recommended to use half clutch condition when commuting in the city traffic condition alone (Engine RPM around idling to 2000 RPM) at 1st gear condition. In other gears and higher RPM avoid using half clutch which will proportionately reduce the clutch life. During acceleration / deceleration disengage the clutch completely, shift the gear and engage the clutch gradually (Not too slowly).

### Recommended up shift speeds

Gear change	kmph	miles
1 <sup>st</sup> - 2 <sup>nd</sup>	25	16
2 <sup>nd</sup> - 3 <sup>rd</sup>	35	22
3 <sup>rd</sup> - 4 <sup>th</sup>	45	28
4 <sup>th</sup> - 5 <sup>th</sup>	60	38
5 <sup>th</sup> - 6 <sup>th</sup>	75	47

### Recommended down shift speeds

Gear change	kmph	miles
6 <sup>th</sup> - 5 <sup>th</sup>	70	44
5 <sup>th</sup> - 4 <sup>th</sup>	55	34
4 <sup>th</sup> - 3 <sup>rd</sup>	40	25
3 <sup>rd</sup> - 2 <sup>nd</sup>	30	19
2 <sup>nd</sup> - 1 <sup>st</sup>	20	13

---

## GEAR SHIFTING, RIDING AND STOPPING

---

### CAUTION

---

- If the clutch lever is released abruptly and throttle opening is done insufficiently the motorcycle will have a rough start and cause the engine to stall.
- If the acceleration is very high and clutch lever is released abruptly, it will cause motorcycle to move suddenly, which will lead to loss of control leading to an accident resulting in injury and or loss of life to rider / other road users / passed by, besides damage to the motorcycle.
- Always exercise utmost caution while releasing clutch and riding the motorcycle.
- Lift gear shift lever up with toe to shift to 2<sup>nd</sup> and subsequent gears.
- As soon as the motorcycle reaches a speed of

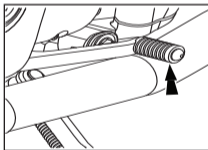

25 kmph in 1<sup>st</sup> gear position, shift to 2<sup>nd</sup> gear and to higher gears as the speed of the motorcycle increases.

---

### NOTE

---

Always start motorcycle with the gear in neutral position.

When the engine speed decreases or while climbing a gradient or running at a reduced speed, shift to the appropriate lower gear to prevent the engine from stalling or straining to pull.

- Always shift to lower gears as appropriate whenever slowing down to stop the vehicle.
- Shift gears to neutral position just before bringing the vehicle to a complete stop always.
- Close throttle fully and release the clutch lever slowly ensuring the motorcycle is in neutral position and neutral lamp is glowing.
- Stop the motorcycle in a safe place, turn "OFF" ignition and switch "OFF" engine kill switch.

# PARKING

## PARKING MOTORCYCLE ON CENTRE STAND

- Park the motorcycle in an upright position.
- Hold handle bar firmly in a straight position.
- Lower center stand, such that, both the legs of the stand are resting on a firm ground.
- Apply pressure on the fulcrum lever on the center stand and pull the motorcycle backward.
- Lock the steering and ensure the handle bar is locked firmly before removing the key from the ignition barrel.

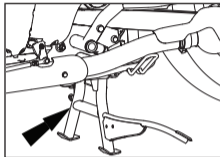

## NOTE

The Center stand is not an of fitment on the Interceptor 650 models. The center stand can however be fitted as an accessory at extra cost. Please contact nearest Royal Enfield Authorised Service Centre, in case you wish to assemble a center stand as an accessory.

## PARKING MOTORCYCLE ON SIDE STAND

- Park the motorcycle in an upright position.
- Extend side stand. Tilt the motorcycle to the left side, till it is supported firmly on the ground.

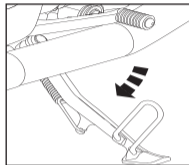

## WARNING

- Ensure both stands are fully retracted before riding the motorcycle.
- Please exercise extreme care while parking and ensure it is parked on a firm and flat surface to avoid the motorcycle from falling over and causing injury to you or to others and damage to the motorcycle parts.
- The Side stand is only designed for the weight of the motorcycle. Do not sit on the motorcycle when it is resting on the side stand. The side stand or frame may become damaged and the motorcycle may fall over.

## TOOLS KIT

The tool kit is located in the right side panel of the motorcycle.

S.No	Description	Qty
1	'C' Spanner	1
2	Allen key 6mm	1
3	Allen Key 5mm	1
4	Allen Key 4mm	1
5	Extension tube	1
6	Ring Spanner 24 x 14 Combination	1
7	Screwdriver 06 x 160	1
8	Double End Spanner 10 x 12	2
9	Tommy bar	1
10.	Spark plug tool	1

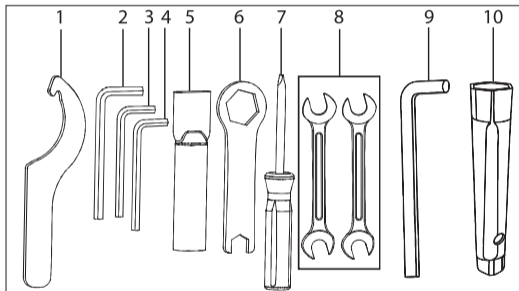

---

## MINOR MAINTENANCE TIPS

---

The following simple maintenance activities will help maintaining your motorcycle. However, for an complete maintenance, we recommend you to get in touch with a Royal Enfield Authorised Service Centre.

### HAND LEVERS, CENTER AND SIDE STAND PIVOTS

- Clean the pivot points and ensure they are free of any dirt, grime, rust, etc.
- Lubricate the pivots.

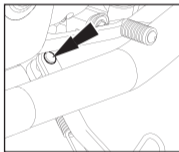

---

### NOTE

---

Wipe off the excess lubricant to prevent dirt and grime from accumulating.

---

### DRIVE CHAIN

---

- Spray drive chain with recommended chain cleaning solvent while simultaneously rotating rear wheel.
- Ensure the drive chain has been sufficiently and completely covered with the cleaning solvent. If necessary use a suitable brush to remove hard deposits from the chain.
- Wait for a few minutes and clean the chain thoroughly from any dirt, grime, etc.
- Rotate rear wheel slowly and simultaneously apply recommended chain lubricant on the chain links.
- Wipe off excess chain lubricant after a few minutes with a clean cloth.

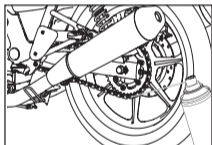
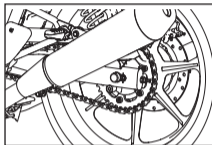

---

## MINOR MAINTENANCE TIPS

---

### ENGINE OIL LEVEL CHECKING

- Ensure vehicle is in straight position on ground level.
- Start the vehicle and gently raise it to approximately 3000 rpm only for 10 seconds.
- Leave the vehicle in idling speed condition for 15 seconds.
- Switch OFF the engine and wait for 10 minutes for oil to settle down.
- Engine oil level should be close to "MAX" condition.
- If in case of oil level is not in above mentioned condition, then top-up the oil to "MAX" condition and repeat the procedure.
- Do not overfill above the "MAX" mark as it may affect the clutch function.

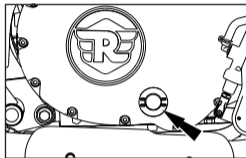

### ENGINE OIL DRAINING

- Ensure vehicle is in straight position on ground level.
- Engine oil should always be drained when the engine is warmed up sufficiently so that the oil drains faster.
- Remove the oil drain bolt and wait for 5 minutes minimum till the engine oil drains completely.
- Drained engine oil quantity will be approx 2.2 L to 2.9 L (Oil drain quantity will vary depend on kilometre covered).

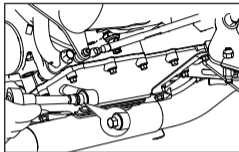

## MINOR MAINTENANCE TIPS

### OIL FILLING DURING OIL SERVICE

- Ensure vehicle is in straight position on ground level.
- Clean the oil filter joint face in crankcase and new oil filter to be assembled along with new rubber gasket.
- Clean the oil drain hole joint face in oil pan and drain bolt.
- New washer to be used. Assemble the drain bolt with the specified loctite.
- Remove the oil filler plug & clean the oil filler cap joint face in crankcase and filler plug.
- Refill the specified fresh engine oil quantity 3.1 litres.
- New oil filler plug 'O' ring to be used and assemble the oil filler plug into the crankcase.
- Check the oil level as per oil level checking procedure given below.

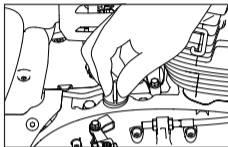

### SPARK PLUG

#### CLEANING AND ADJUSTING PLUG GAP

- Disconnect spark plug caps from the spark plugs.
- Locate spark plug spanner on the spark plug, loosen spark plug and remove it from cylinder head.
- Check spark plug for carbon deposits and center electrodes for uneven wear.
- Clean the insulator tip and electrodes of the plug carefully.
- Check and set electrode gap between 0.7 to 0.8 mm.
- Always replace spark plugs only as per recommended specification.
- Apply a thin film of "anti seize" on the spark plug mounting and threads fix the spark plug by hand tightening.
- Tighten spark plug to torque 10 to 15 Nm by using a spark plug spanner.

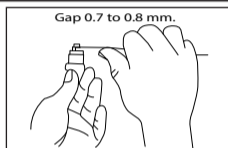

---

## MINOR MAINTENANCE TIPS

---

### CHECKING BRAKE FLUID

---

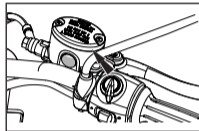

#### Front Brake

Place your motorcycle in an upright position on a firm, level surface.

**Front :** Check that the brake fluid reservoir is horizontal and that the fluid level is center of the window consider as a minimum level.

**Rear :** Check that the brake fluid reservoir is horizontal and that the fluid level is between the "MAX" level and "MIN" level mark.

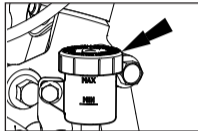

#### Rear Brake

### CAUTION

---

- Brake fluid is highly corrosive and can cause damage to painted parts. Please ensure that brake fluid does not spill on any part of the motorcycle. In the event of a spill, please clean the area immediately with a soft wet cloth (preferably a wet cloth) to avoid damage.
- Do not mix DOT 4 & other brake fluid together.

---

## MINOR MAINTENANCE TIPS

---

### NOTE

- Clean the filler cap before removing. Use only DOT 4 brake fluid from sealer container.
- Use only the specified brake fluid; otherwise, the rubber seals may deteriorate, causing leakage.
- Refill with the same type of brake fluid. Adding a brake fluid other than DOT 4 may result in a harmful chemical reaction.
- Be careful that water or dust does not enter the brake fluid reservoir when refilling. Water will significantly lower the boiling point of the fluid and may result in vapor lock and dirt may clog the ABS hydraulic unit valves.



### WARNING

- An insufficient brake fluid level will cause the brake system to fail.
- Old brake fluid reduces the braking effect.
- Make sure that brake fluid for the front and rear brake is changed in accordance with the periodic maintenance schedule.
- Keep brake fluid out of the reach of children.
- Do not allow brake fluid to come into contact with the skin, the eyes or clothing.
- Brake fluid is highly corrosive and can cause damage to painted parts. Ensure brake fluid does not spill on any part of the motorcycle, in the event of spill please clean the area immediately with a soft cloth to avoid damage.

# MINOR MAINTENANCE TIPS

## INSPECTION OF TYRES AND WHEELS

- Inspect the tyres periodically for tread wear, cracks and cuts.

Minimum tread depth	
Front tyre: 1 mm	Rear tyre :2 mm

- Check and remove stone, splinters, nails or other particles embedded in the tyre treads.
- Periodically inspect wheels for spokes damage and wheel rim for wobbling or run out (It's applicable for spokes wheel model only)
- Check uniform seating of the tyre beading on the rim whenever the tyre is reassembled.
- Use only recommended tyres and tubes, inflated to correct air pressure as given below.



Tyre pressure	Front	Rear
Solo	32 psi/2.24 kg/cm <sup>2</sup>	36 psi/2.53 kg/cm <sup>2</sup>
With Pillion	32 psi/2.24 kg/cm <sup>2</sup>	39 psi/2.74 kg/cm <sup>2</sup>



## WARNING

- It is recommended to operate the motorcycle with correct tyre pressure as under inflated tyres may cause tyre to overheat and may result in tyre damage and may cause injury to the rider.
- It is recommended to use Royal Enfield recommended tyre specification in case of replacement of new tyres, it is recommended to use the same specification of the tyre recommended by Royal Enfield, failure to adhere the same may result in tyre damage and may cause injury to the rider.

---

## MINOR MAINTENANCE TIPS

---

### BRAKE PADS

---

- The front and rear brake pads must be checked for wear at the intervals specified in the periodic maintenance chart.

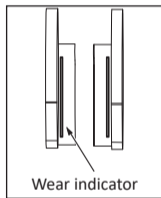
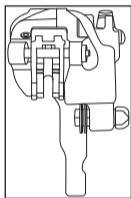

**Front/Rear :** The pads need to be replaced if a brake pad is worn to the indicator.

### NOTE

---

- Royal Enfield Motorcycles fitted with disc brakes have the optimum braking systems and are built to give a superior and safer braking performance under all conditions.
- Disc braking systems can produce a mild noise under certain riding conditions. This is absolutely normal and characteristic of the disc brake pads across the motorcycle industry. This in no way will affect the performance of the motorcycle or the braking system.
- At Royal Enfield, we have robust and rigorous testing and development protocols and adhere to global validation standards of quality and durability. We are committed to giving our customers the best possible ownership experience with our motorcycles.

## MINOR MAINTENANCE TIPS

### FRONT WHEEL REMOVAL FOR ALLOY WHEEL

- Ensure motorcycle is upright on a firm and flat surface.
- Place a wooden block on the front end of engine to support the motorcycle and ensure front wheel is off the ground by minimum 2 inches.
- From wiring harness RH side disconnect the speedo drive coupler.
- Loosen the pinch bolt on the front fork bottom right side.
- Remove the axle nut along with washer, hold the wheel axle on the right side and loosen hex nut on the left completely.
- Remove axle nut and washer from wheel axle.

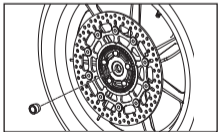
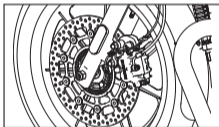
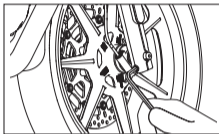

- Tap and remove the front wheel spindle, gently tap axle from left side while supporting wheel at the bottom then remove axle from the right side.

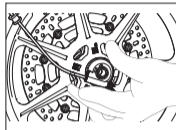

### CAUTION

Take care to secure the wheel spacers and speed sensor while removing the axle from the forks.

- Slide out the front wheel from the forks.

### CAUTION

Do not press the brake lever when front wheel is removed as this will result in the brake pads coming too far out of the brake caliper.

- Place a 4 mm thick wooden piece or cardboard sheet between the brake pads to avoid pads activation in the event the front brake lever is accidentally pressed.
- Take care not to damage the front brake disc or toner ring as it will affect the braking system and ABS.

---

## MINOR MAINTENANCE TIPS

---

### FRONT WHEEL REASSEMBLY FOR ALLOY WHEEL

- Remove the wooden piece / cardboard sheet placed between the brake pads.
- Locate speedo drive to its correct position on the right side.
- Locate stepped spacer to the wheel hub on left side.
- Insert the wheel along with speedo drive and spacer between the fork ends. Ensure the brake disc is located between the brake pads.
- Support front wheel at the bottom and ensure the mounting holes are aligned to insert the wheel axle along the right side fork end. Gently tap axle into wheel till the threaded portion of axle is fully visible on the left side fork end.

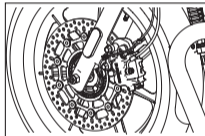

- Assemble washer and nut on axle.
- Hold the wheel axle firmly on right side and tighten axle nut firmly on right side to a torque of 70 Nm.
- Tighten pinch bolt completely on fork end to a torque of 25 Nm.
- Rotate wheel to check for smooth rotation.
- Connect the speedo wire coupler and check for proper working of speedometer.
- Press brake lever and check front brake efficiency.

---

### CAUTION

---

Please exercise utmost caution while reassembling the front wheel on the motorcycle. Please ensure the wheel is fitted correctly before attempting to ride the motorcycle. Failure to do so may result in the motorcycle not performing correctly, may lead to an accident causing injury to you / other road users and may lead to loss of life.

---

## MINOR MAINTENANCE TIPS

---

### REAR WHEEL REMOVAL FOR ALLOY WHEEL

---

- Ensure motorcycle is upright on a firm and flat surface with the rear wheel atleast 6 inches raised above from the surface.
- Observe and mark the alignment indexes on both chain adjuster on left and right side swing arm.
- Loosen the lock nuts and adjuster nuts fully on the left and right side chain adjuster.
- Hold wheel spindle on left side firmly and loosen hex nut on right side.
- Remove the nut and washer from the wheel spindle.
- Push rear wheel fully into the swing arm.

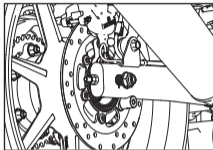

- Support rear wheel from bottom and pull out wheel spindle from the left side swing arm from the clips on swing arm.
- Release the brake hose gently and remove caliper assembly from swing arm on right side.

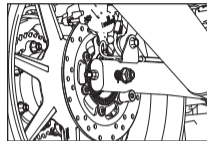

---

### CAUTION

---

- Ensure brake hose does not get damaged or kinked while removing.
- Support caliper assembly suitably and away from swing arm.
- Release the chain from the sprocket and ensure it does not get jammed or damaged when removing rear wheel.
- Remove support from wheel bottom and gently slide out rear wheel from the swing arm with rear sprocket, brake disc and spacers.

---

## MINOR MAINTENANCE TIPS

---

### CAUTION

Do not press the rear brake pedal when the rear wheel is being removed as this will cause the brake pads to dislocate from the brake caliper.

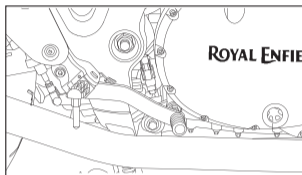

- Place a 4 mm thick wooden piece or cardboard sheet between the brake pads to avoid activation of brake pads if rear brake pedal is accidentally pressed.

---

### CAUTION

---

DO NOT pull up the rear brake pedal to lift or raise the motorcycle for any reason.

---

### REAR WHEEL REASSEMBLY FOR ALLOY WHEEL

---

- Ensure that the long stepped spacer is located on the brake disc side and the short spacer is located on the sprocket side of the wheel hub firmly.
- Ensure that the chain adjuster are located properly inside the swing arm left and right sides.
- Locate caliper assembly on the tab along the swing arm right side.
- Locate rear wheel with the sprocket to the left side ensuring the brake disc in- between the brake pads on right side.
- Lift up the rear wheel and ensure that the slots in the swing arm brake caliper bracket holes in chain adjusters and the center hole in the hub are aligned.

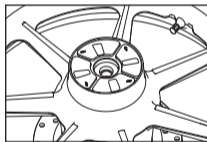
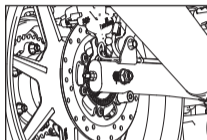

---

## MINOR MAINTENANCE TIPS

---

- Support rear wheel suitably and insert rear wheel spindle along the left sides wing arm into the wheel hub.
- Ensure that the long stepped spacer is located along the brake side and the short spacer is located along the sprocket side on the wheel hub.
- Tap spindle gently into wheel hub slot till the threads are completely visible on the right side.
- Assemble the drive chain on the sprocket and ensure it is seated correctly.
- Check for free and smooth rotation of the rear wheel.

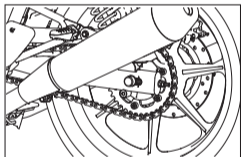
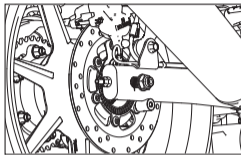

- Assemble washer and hex nut on wheel spindle on right side.
- Tighten chain adjuster nuts on left and right adjuster such that the index marks are aligned correctly on both sides of the swing arm.
- Check and ensure correct chain tension and wheel alignment.
- Hold spindle firmly on left side and tighten hex nut on right side set torque to 70 Nm.
- Locate the brake hose in the clips along the swing arm right side.
- Check rear brake for proper operating efficiency.

---

### CAUTION

---

Please exercise utmost caution while reassembling the rear wheel on the motorcycle.

Please ensure the wheel is fitted correctly before attempting to ride the motorcycle.

Failure to do so will result in poor performance of motorcycle which may lead to an accident causing injury to you / other road users and may lead to loss of life.

## MINOR MAINTENANCE TIPS

### FRONT WHEEL REMOVAL FOR SPOKES WHEEL

- Ensure motorcycle is upright on a firm and flat surface.
- Place a wooden block on the front end of engine to support the motorcycle and ensure front wheel is off the ground by minimum 5 cm.
- From wiring harness RH side disconnect the speedo drive coupler.
- Loosen the pinch bolt on the front fork bottom right side.
- Remove the axle nut along with washer, hold the wheel axle on the right side and loosen hex nut on the left completely.
- Remove axle nut and washer from wheel axle.

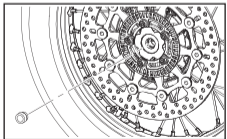
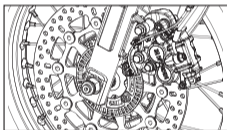

- Tap and remove the front wheel spindle, gently tap axle from left side while supporting wheel at the bottom then remove axle from the right side.

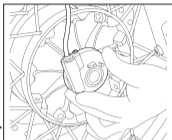

### CAUTION

Take care to secure the wheel spacers and speed sensor while removing the axle from the forks.

- Slide out the front wheel from the forks.

### CAUTION

Do not press the brake lever when front wheel is removed as this will result in the brake pads coming too far out of the brake caliper.

- Place a 4 mm thick wooden piece or cardboard sheet between the brake pads to avoid pads activation in the event the front brake lever is accidentally pressed.
- Take care not to damage the front brake disc or toner ring as it will affect the braking system and ABS.

---

## MINOR MAINTENANCE TIPS

---

### FRONT WHEEL ASSEMBLY FOR SPOKES WHEEL

- Remove the wooden piece / cardboard sheet placed between the brake pads.
- Locate speedo drive to its correct position on the right side.
- Locate stepped spacer to the wheel hub on left side.
- Insert the wheel along with speedo drive and spacer between the fork ends. Ensure the brake disc is located between the brake pads.
- Support front wheel at the bottom and ensure the mounting holes are aligned to insert the wheel axle along the right side fork end. Gently tap axle into wheel till the threaded portion of axle is fully visible on the left side fork end.

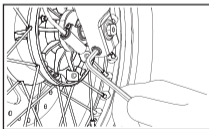
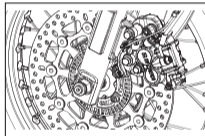

- Assemble washer and nut on axle.
- Hold the wheel axle firmly on right side and tighten axle nut firmly on right side to a torque of 70 Nm.
- Tighten pinch bolt completely on fork end to a torque of 25 Nm.
- Rotate wheel to check for smooth rotation.
- Connect the speedo wire coupler and check for proper working of speedometer.
- Press brake lever and check front brake efficiency.

---

### CAUTION

---

Please exercise utmost caution while reassembling the front wheel on the motorcycle. Please ensure the wheel is fitted correctly before attempting to ride the motorcycle. Failure to do so may result in the motorcycle not performing correctly, may lead to an accident causing injury to you / other road users and may lead to loss of life.

---

## MINOR MAINTENANCE TIPS

---

### REAR WHEEL REMOVAL FOR SPOKES WHEEL

---

- Ensure motorcycle is upright on a firm and flat surface with the rear wheel at least 6 inches raised above from the surface.
- Observe and mark the alignment indexes on both chain adjuster on left and right side swing arm.
- Loosen the lock nuts and adjuster nuts fully on the left and right side chain adjuster.
- Hold wheel spindle on left side firmly and loosen hex nut on right side.
- Remove the nut and washer from the wheel spindle.
- Push rear wheel fully into the swing arm.

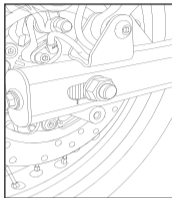

- Support rear wheel from bottom and pull out wheel spindle from the left side swing arm from the clips on swing arm.
- Release the brake hose gently and remove caliper assembly from swing arm on right side.

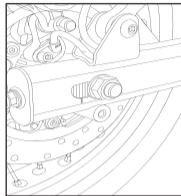

---

### CAUTION

---

- Ensure brake hose does not get damaged or kinked while removing.
- Support caliper assembly suitably and away from swing arm.
- Release the chain from the sprocket and ensure it does not get jammed or damaged when removing rear wheel.
- Remove support from wheel bottom and gently slide out rear wheel from the swing arm with rear sprocket, brake disc and spacers.

## MINOR MAINTENANCE TIPS

### CAUTION

Do not press the rear brake pedal when the rear wheel is being removed as this will cause the brake pads to dislocate from the brake caliper.

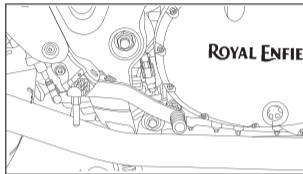

- Place a 4 mm thick wooden piece or cardboard sheet between the brake pads to avoid activation of brake pads if rear brake pedal is accidentally pressed.

### CAUTION

DO NOT pull up the rear brake pedal to lift or raise the motorcycle for any reason.

### REAR WHEEL ASSEMBLY FOR SPOKES WHEEL

- Ensure that the long stepped spacer is located on the brake disc side and the short spacer is located on the sprocket side of the wheel hub firmly.
- Ensure that the chain adjuster are located properly inside the swing arm left and right sides.
- Locate caliper assembly on the tab along the swing arm right side.
- Locate rear wheel with the sprocket to the left side ensuring the brake disc in-between the brake pads on right side.
- Lift up the rear wheel and ensure that the slots in the swing arm brake caliper bracket holes in chain adjusters and the center hole in the hub are aligned.

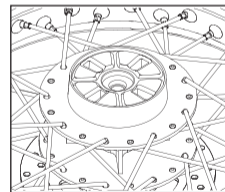
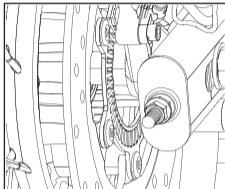

---

## MINOR MAINTENANCE TIPS

---

- Support rear wheel suitably and insert rear wheel spindle along the left sides wing arm into the wheel hub.
- Ensure that the long stepped spacer is located along the brake side and the short spacer is located along the sprocket side on the wheel hub.
- Tap spindle gently into wheel hub slot till the threads are completely visible on the right side.
- Assemble the drive chain on the sprocket and ensure it is seated correctly.
- Check for free and smooth rotation of the rear wheel.

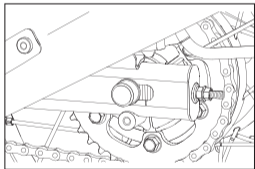
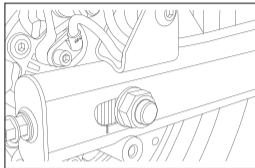

- Assemble washer and hex nut on wheel spindle on right side.
- Tighten chain adjuster nuts on left and right adjuster such that the index marks are aligned correctly on both sides of the swing arm.
- Check and ensure correct chain tension and wheel alignment.
- Hold spindle firmly on left side and tighten hex nut on right side set torque to 70 Nm.
- Locate the brake hose in the clips along the swing arm right side.
- Check rear brake for proper operating efficiency.

---

### CAUTION

---

Please exercise utmost caution while reassembling the rear wheel on the motorcycle.

Please ensure the wheel is fitted correctly before attempting to ride the motorcycle.

Failure to do so will result in poor performance of motorcycle which may lead to an accident causing injury to you / other road users and may lead to loss of life.

---

## MINOR MAINTENANCE TIPS

---

### CLUTCH CABLE FREE PLAY INSPECTION / ADJUSTMENT

---

- Clutch cable free play, plays a major role in clutch life & it is recommended to adjust whenever required for a good clutch life.

### CLUTCH LEVER FREE PLAY SPECIFICATION

---

- Free play should be measured at ball end of clutch lever and should be 9-12 mm when handlebars are at LH position (Refer the image **A**). Straight should be checked at 10-20 mm (Refer the image **B**).
- For adjustment follow below procedure.

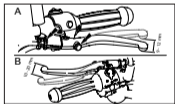

---

### NOTE

Clutch lever to be actuated 3 times before any measurement.

### MINOR ADJUSTMENT - CLUTCH CABLE LEVER END

---

- Minor adjustment of free play can be done at clutch cable lever end.
- Loosen the cable outer lock nut.
- Turn the nut clockwise to reduce the play or anticlockwise to increase the free play.
- Tighten firmly the lock nut after adjustment is done.
- After the adjustment, check the free play and confirm for specification.

### MAJOR ADJUSTMENT - CLUTCH CABLE COVER END

---

- Major adjustment of free play can be done at clutch cable cover end.
- Loosen the cable outer lock nut.
- Turn the nut clockwise to reduce the play or anticlockwise to increase the free play.
- Firmly tighten two lock nuts using two spanners after adjustment is done.
- After the adjustment, check the free play and confirm for specification.

## MINOR MAINTENANCE TIPS

### CAUTION

- If you are not comfortable to adjust free play as per stated procedure, please visit near by service centre.
- If desired free play is not achieved or there is a suspect of clutch slip-keep positive free play & reach nearest service centre.
- Adjuster nut should rest properly in the threaded region. No overhanging (Ref. image)
- Clutch free play should be checked and adjusted only when the engine is cold.
- During clutch play checking, check the clutch cable for any abnormality as it is in vehicle condition.
- If any abnormality suspected, reach nearest service centre.

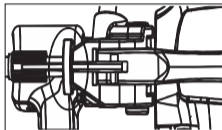

### DRIVE CHAIN TENSION (Free Play 20-30 mm)

- Park motorcycle up right on a firm and flat surface.
- Ensure the motorcycle is in neutral position.
- Measure the drive chain free play as shown. The drive chain free play is 20 to 30 mm.
- If the drive chain free play is found to be incorrect adjust as follows:
  - a. Loosen the axle nut of the rear wheel axle.
  - b. Loosen the lock nut on the adjuster at both end of the swing arm.
  - c. To reduce the free play, tighten the adjuster nut on the adjuster evenly.

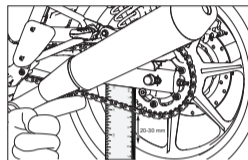

---

## MINOR MAINTENANCE TIPS

---

- d. To increase the free play, loosen the adjuster nuts evenly and push the rear wheel forward.
- e. Check the chain for correct chain tension.
- f. Ensure that the index marks on the adjuster and swing arm are same on both left and right side of the swing arm.
- g. Hold spindle firmly to the left side and tighten rear hex nut to a torque of 70 Nm.
- h. Tighten the adjuster locknut using a 24 mm spanner.

---

### **WARNING**

---

Chain slackness beyond 30 mm will lead to chain slippage and may also cause increased wear rates to chain and sprockets.

Please ensure the both wheels are aligned correctly, after adjusting the chain and before tightening the rear wheel spindle nut.

---

## BATTERY AND MAINTENANCE

---

- The Motorcycle is provided with 12 V - 12 Ah battery.
- The battery must be periodically checked for cleanliness and corrosion free terminals.

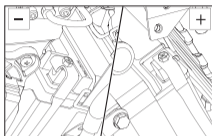

---

### NOTE

---

The poor contact or loose fitment of battery terminals may cause ECU failure.

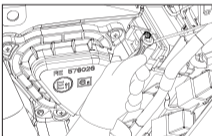

---

## DISMANTLING

---

- Switch "OFF" the engine and remove ignition key from the key barrel.
- Disconnect battery negative (- ve) terminal bolt.

---

## MINOR MAINTENANCE TIPS

---

- Remove 3 nos. hex head bolts from tool box to access the battery.

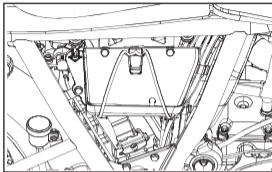

- Disconnect battery positive (+ve) terminal from battery.

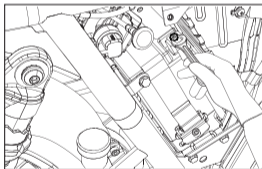

- Pull battery strap (belt) downwards and release strap lock from battery strap bracket.

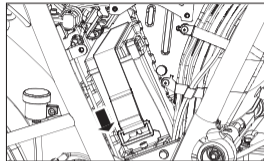

- Loosen and remove hex flange head screw from battery strap bracket.

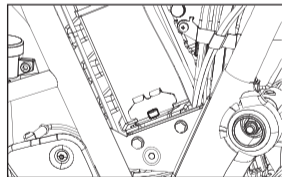

---

## MINOR MAINTENANCE TIPS

---

- Remove battery strap bracket from battery tray.

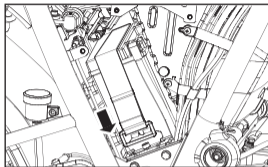

- Remove battery from tray.

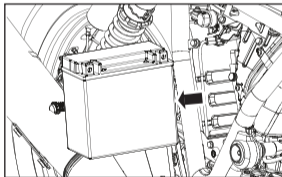

---

### **WARNING**

---

Always disconnect the black negative (-ve) battery cable first and then the red positive (+ve) cable while removing the battery connections.

---

### **NOTE**

---

For checking the battery voltage contact Royal Enfield Authorised Service Centre or battery service centre.

## MINOR MAINTENANCE TIPS

### ASSEMBLY

- Assemble battery into tray.

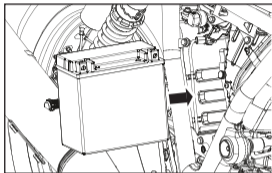

- Place battery strap bracket into battery tray.

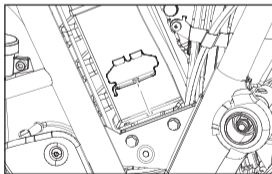

- Locate and tighten flanged head screw into battery strap bracket.

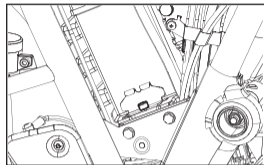

- Pull battery strap (belt) downwards to fix strap lock into battery strap bracket.

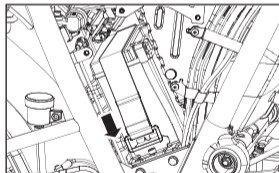

## MINOR MAINTENANCE TIPS

- Connect battery red positive (+ve) terminal bolt.

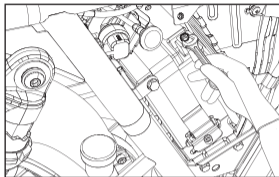

- Locate and tighten 3 nos. hex head bolts into tool holder.

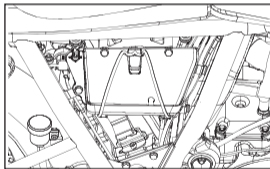

- Connect black battery negative (-ve) terminal bolt.

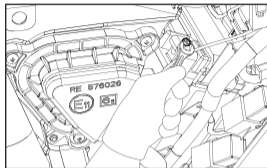

---

### CAUTION

---

Connect the red (+ve) positive terminal first and then connect black (-ve) negative terminal only.

---

### NOTE

---

Clean the wire terminals free from corrosion and keep the terminals coated with petroleum jelly.

---

### CAUTION

---

Keep the red (+ve) positive terminal and (-ve) negative terminal cables firmly connected to the respective battery terminals. Failure to do so may result in damage to the motorcycle electrical system.

# MINOR MAINTENANCE TIPS

## CHANGING ELECTRICAL COMPONENTS

### HEADLAMP DISMANTLING

- Gently loosen and remove the headlamp mounting screws both sides from headlamp cowl by using screwdriver available in the tool kit.
- Gently pullout the headlamp rim along with reflector assembly.
- Disconnect head lamp coupler.
- Gently loosen and remove the headlamp rim screws 2 Nos from headlamp cowl by using

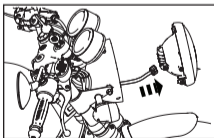
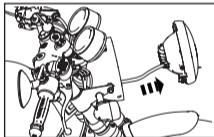
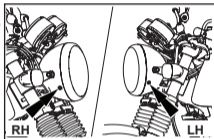

screwdriver available in the tool kit

- Gently release the headlamp holding clips 4 nos from head lamp rim.
- Remove the rim from head lamp.

### NOTE

- The headlamp has a LED lighting system. In the event of failure, the headlamp LED assembly should be replaced.
- Contact an Royal Enfield Authorised Dealer/ Service Centre to replace the same.

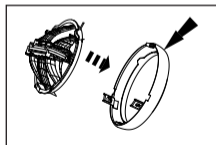
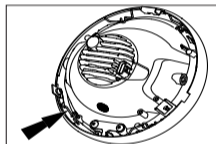
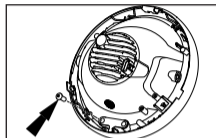

# MINOR MAINTENANCE TIPS

## HEADLAMP ASSEMBLY

- Assemble the rim to head lamp.
- Lock the headlamp holding clips 4 nos to head lamp rim.
- Tighten and refit the headlamp rim screws 2 Nos to headlamp cowl.

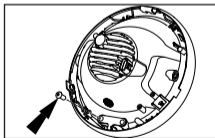
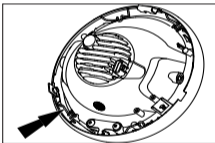
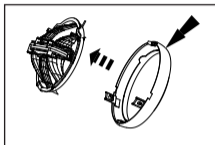

- Connect head lamp coupler.

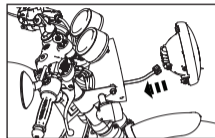

- Refit the headlamp rim along with reflector assembly.

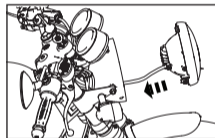

- Tighten and refit the headlamp mounting screws both sides to headlamp cowl by using screwdriver.

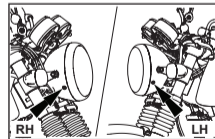

---

## MINOR MAINTENANCE TIPS

---

### HEADLIGHT BEAM ADJUSTMENT

---

- The headlight beam focus can be adjusted in vertical direction by using the adjusting screws.
- Loosen the bottom mounting screw to adjust headlamp position. After adjusting the focus tighten the bottom mounting screw.

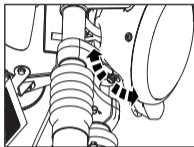

### TAIL LAMP BULB

---

- Unlock the side panel RH.
- Remove the seat assembly by pulling seat lock cable.
- Remove the tail light cover by unscrewing its mounting screw.
- Hold the bulb, press inside and rotate anticlockwise to remove the tail light bulb from its holder using a clean cloth.
- Replace the bulb using a soft clean cloth.
- Re-assemble the tail light in the reverse order of dismantling process.

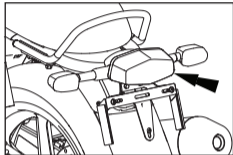

---

## MINOR MAINTENANCE TIPS

---

### TRAFFICATOR BULB REPLACEMENT

---

- Remove the screw from the trafficator housing.
- Open the indicator housing.
- Remove the bulb holder with help of a screw driver.
- Remove the bulb and replace the same using a soft and clean cloth.
- Refit the holder to its proper position.
- Fix the rubber gasket cover.
- Assemble the indicator housing cover.

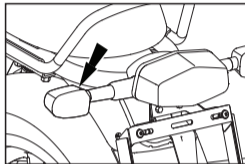

---

## MINOR MAINTENANCE TIPS

---

### FUSE AND FUSE CARRIER

---

- The fuse carrier is located under the seat.
- Unlock side panel RH.
- Release seat lock by pulling knob and remove the seat.

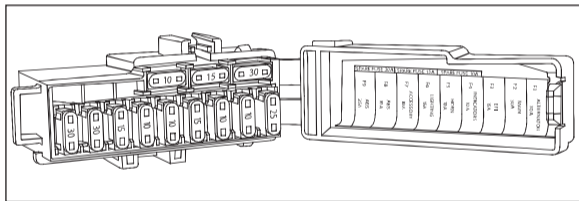

---

### WARNING

Electronic Control Unit (ECU) may fail due to loose electrical connections, loose battery terminals, etc. Hence, it is very important to keep all the electrical connections intact.

# MINOR MAINTENANCE TIPS

## MINI BLADE FUSE USAGE LIST

Fuse ID Number	Color	Rating	Remarks
1	Green	30 A	Alternator
2	Green	30 A	Main Fuse
3	Blue	15 A	Ignition Fuse-EFI
4	Red	10 A	Signalling Fuse
5	Red	10 A	Horn Fuse
6	Blue	15 A	Lighting Fuse (Head Lamp)
7	Red	10 A	Accessory Fuse
8	Red	10 A	ABS Fuse
9	White	25 A	ABS Fuse
Spare fuse list			
1	RD	10A	Spare fuse 1
2	BU	15A	Spare fuse 2
3	GN	30A	Spare fuse 3



### WARNING

Please get the electrical system of your motorcycle checked thoroughly and get the faults corrected immediately after experiencing any fuse failure. Failure to do so may result in repeated fuse failure.

Usage of fuses other than specified rating or usage of any other conductive materials or low grade fuses will damage the complete electrical system.

Please ensure to replace a spare fuse in the holder at the earliest opportunity.

Any attempt to jumper a defective fuse gives rise to the risk of a short-circuit and fire. Always replace a defective fuse with a new fuse of the same rating.

### NOTE

Make sure the ignition switch is in OFF position when replacing the bulbs, fuses and electrical parts

---

## MINOR MAINTENANCE TIPS

---

### AIR FILTER

---

- Remove the screw from the side panel bottom side and remove side panel.
- Remove the air filter cover screws and then take out air filter box cover.
- Pull out filter element and check for dirt. Clean filter element carefully.

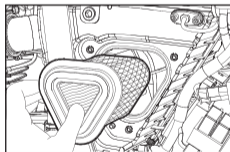
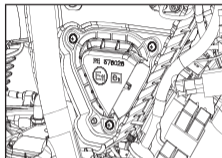

### NOTE

---

Usage of high pressure compressed air is not recommended to clean air filter element. Fitment of air filter element is in the reverse order of removal process.

---

# LONG TRIP PRECAUTIONS

---

## CHECKS PRIOR TO THE COMMENCEMENT OF LONG JOURNEY

---

- Service the motorcycle at a Royal Enfield Authorised Dealer/Service centre.
- Ensure sufficient quantity of fuel is always available in the fuel tank for the journey planned.
- Check and correct tyre pressure if necessary.

## CHECK ALL OF THESE ASPECTS BEFORE LONG RIDE

---

- Any loose fasteners.
- Condition of the tyres.
- Correct oil level in engine.
- Working of all lights and horn.
- Proper drive chain tension.
- Clutch cable free play.

## ITEMS TO BE CARRIED

---

- Tool kit.
- Trafficator light and fuse.
- Accelerator and clutch cable.
- Spark plug, spark plug cap and fuel hose.
- Spare tubes (It's applicable for spokes wheel model).

---

## REAR SUSPENSION SETTING

---

- Rest the motorcycle on center stand.
- Ensure the tyre pressure is at recommended specification.
- Ensure adjuster are clear of all dirt and debris before adjusting, if they have dirt or debris please clean it suitably before adjusting.
- The adjuster is a 5 step adjuster and it is kept at first notch position.
- Adjust shock preload by rotating the adjuster clockwise using C spanner to decrease the preload.
- Adjust shock preload by rotating anti-clockwise using C spanner to increase preload.
- Make the same adjustments on both sides, uneven adjustment may lead to discomfort to the rider.

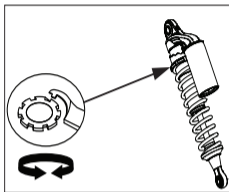

### NOTE

- Adjusting the suspension requires a C spanner. It is recommended to use the C spanner that is given in your vehicle tool kit. Extension tube to be used for leverage purposes.
- The best spring preload setting is achieved when it is set for the weight of the rider and that of any luggage and a passenger.
- We recommend to increase the preload and keep it at final notch for fully loaded (GVW condition), thus ensuring an ideal compromise between handling and stability.
- Do not use any additional tools for this purpose other than C spanner.

## REAR SUSPENSION SETTING

Condition	Max reference payload	Suspension setting notch	Tyre pressure (psi)	
			Front	Rear
Unladen / One up Loading / Rider only.	Rider upto 90 kg	1 <sup>st</sup>	32	36
Laden / Two up / Rider + Pillions / Rider + Pillion + Accessories	Upto a maximum of 180 kg payload (Inc of rider weight, pillion weight and accessories)	5 <sup>th</sup>	32	39

\* Ensure the preload is set equally on the LH and RH rear suspension.

---

## WASHING PROCEDURE

---

### PRECAUTIONS

---

- Remove ignition key and seal the ignition key barrel slot using adhesive tape.
- Please remove tool kit and other relevant documents if any inside the left side panel before proceeding for washing of the motorcycle.
- Cover the silencer tail pipe, horn and control switches with suitable plastic bags and tie if firmly to prevent water entry.
- Wash the motorcycle only when the engine is in cold condition.
- Do not remove side panels while washing to avoid water entry.
- Brush engine area with a recommend non corrosive solvent to remove dirt or grease.
- Use low pressure water jet to clean.
- Never spray water with great force on head lamp, speedometer, tripper, flasher lights, front and rear wheel hubs, electrical connections and wires, control cables, spark plug, battery, ABS ECU, EMS ECU, side mirrors, steering stem etc.
- Do not use high pressure washers or steam jet cleaners near the seal of headstock bearing or steering stem bearing, seal of wheel bearing, brake calipers, air intakes & exhaust outlets.
- Do not apply any corrosive solvent on painted surfaces or rubber parts.

---

## WASHING PROCEDURE

---

- Use lukewarm water and mild detergent on the painted components to remove dirt, etc.
- Clean motorcycle thoroughly with plain water to remove the detergent.
- Never spray water towards bottom side of instrument cluster directly to avoid water entry through breather holes.
- If possible, use compressed air and blow off water particles from the obscure areas of the motorcycle, electrical connections etc.
- Once the motorcycle has been ridden in salty conditions (i.e. During winter in places where road salt is used) or near coastal areas it is recommended to wash your motorcycle with cold water after the ride to prevent corrosion or rust build-up. Please do not use warm water for washing as it may damage the motorcycle due to chemical reaction with the salt. After washing process once the motorcycle is completely dry it is recommended to apply anti corrosion spray on all the metal and chrome plated areas to protect the parts from corrosion.
- It is recommended not to apply the anti-corrosion spray on the brake discs.
- Do not use petrol, brake oil or other flammable liquids to clean or wash on electronic parts.
- The parts chosen using motorcycle configurator should not be washed with soap or chemical, use only with plain water.
- No direct jet at the edges of decal, electrical parts, coupler joints, silencer tail pipe, radiator lubrication points like steering cone kit, brake pedal, wheel bearings, chain, brake cam & swing arm bushes to be washed in spray mode only (not in jet mode).

---

## WASHING PROCEDURE

---

### AFTER WASHING

---

- Ensure, the motorcycle is thoroughly dry by wiping with a clean soft lint free absorbent cloth or chamois leather.
  - Remove all adhesive tapes.
  - Lubricate control cables, pivots for footrest, side stand, center stand, brake and gear shifter linkages, drive chain etc., With lube oil.
  - Polish the painted and plated surfaces using recommended automobile polishing wax.
  - Start the engine and allow to run at an idling speed for a few minutes to warm up engine.
- Drive the motorcycle slowly, apply both the brakes intermittently to dry up the water in brake pads.
  - Please clean / wipe out water spoils completely inside the left side panel before keeping tools kit and other relevant documents inside the left side panel.

---

## STORAGE PRECAUTIONS

---

In-case your motorcycle is not going to be used for a month or more, the following precautions should be taken.

- Get the motorcycle serviced through a Royal Enfield Authorised Service Centre.
- Drain the fuel completely from the fuel tank and induction system.
- Remove spark plug, Pour in about 5 ml of clean engine oil through spark plug hole. Close the hold and crank engine several times and refit spark plug.
- Clean drive chain thoroughly and apply Royal Enfield recommended chain lubricant.
- Wipe off excess lubricant after 5 minutes of application.
- Remove charging circuit fuse from the fuse box.
- Store the battery in a cool, dry and well ventilated place.
- Cover the silencer with suitable bags to prevent moisture entry. Set the motorcycle on its center stand.
- Apply anti rust solutions on all plated parts. Take care not to apply this solution on chrome, rubber or painted parts. Store motorcycle in a clean covered area free of moisture and dust.
- For re-use after storage, it is preferable to get the motorcycle prepared through a Royal Enfield Authorised Service Centre to ensure the motorcycle is restored to its peak operating conditions.
- If the motorcycle is not used for a month or longer, It is advised to disconnect battery terminals and remove the battery. Before refitting the battery in the motorcycle, check the battery voltage is within specification, if not, recharge it from authorized service workshop/battery dealer.

---

## TROUBLESHOOTING

---

We have listed below a few basic checks in case your motorcycle is not functioning. If in case the problem is not rectified after these checks, it is necessary to get the motorcycle checked by a Royal Enfield Authorised Dealer/ Service Centre to rectify the problem and to ensure trouble free performance.

Symptom	Observations	Check for/Remedy
Engine does not start	If the Ignition/Engine kill switch in OFF position	Switch ON ignition
	If inadequate fuel level in fuel tank	Top up the fuel
	If the lights are dim/weak horn sound	Weak or discharged battery / problem in charging circuit Contact Authorised service center
	If fuse is blown	1. Replace the fuse with same rating 2. Contact Authorised service center if problem persists
	Connection issue with spark plug, cap, high tension cable	Reconnect spark plug, cap and high tension cable.

## TROUBLESHOOTING

Symptom	Observations	Check for/Remedy
Engine starts but shuts off immediately	If the MIL lamp in cluster is glowing	Contact Authorised service center
Engine misfires & runs erratically/stops.	If any adulteration/water in fuel	Contact Authorised service center
	If the engine is too hot	Switch OFF the engine and allow it to cool down
Poor pickup	If engine RPM raises disproportionately to the vehicle speed	Adjust the clutch free play and contact Authorised service center
ABS (Anti-lock Braking System)	If the ABS lamp continuously ON	Contact Authorised service center

---

## **ENVIRONMENT CARE**

---

### **BE AN ENVIRONMENTALLY CONSCIOUS RIDER**

---

You've ridden through some beautiful places on your Royal Enfield. Won't you like to keep them that way? Here are some tips to help you keep those places unspoilt so that others can enjoy them too:

---

### **DISPOSAL OF END OF LIFE - PARTS/VEHICLE**

---

While your liquid waste like engine oil, coolant and other cleaning solvents need to be regularly replaced, what happens to them? Make sure they are not dumped in the soil or water bodies.

You shall store them in a container and handover to an Govt authorized recycling agent, If any or Royal Enfield Service Centre.

In the case of battery, tyres, plastic parts, electric or electronic parts and oil filter shall be handed over only to an authorized recycling agent, If any or Royal Enfield Service Centre.

The cleaning solvents or sprays whichever used for cleaning your bike shall be disposed in an environmentally friendly manner.

In case you want to dispose your vehicle considered as an end of life vehicle, please handover the vehicle only to an authorized/registered vehicle scrapping facility near you or contact local authorities to follow due process.

## PERIODICAL MAINTENANCE

The maintenance schedule detailed here will help you to maintain your Interceptor 650 motorcycle meticulously to get along trouble free service. The schedule provided herein is based upon an average riding conditions and indicates the km at which regular inspections, adjustments, replacements and lubrications are to be carried out. The frequency of the maintenance must be shortened depending upon the severity of the driving condition or if the motorcycle is used in a very dust environment. Contact the nearest Royal Enfield Authorised Service Centre for expert advice and to carry out the required maintenance.

SI. No.	DESCRIPTION	PERIODICAL MAINTENANCE (Whichever is earlier)					
		0.5	7.5	15	22.5	30	37.5
	km (x 1,000)						
	miles (x 1,000)	0.3	4.66	9.32	13.98	18.64	23.3
	Months	1.5	12	24	36	48	60
1	Engine oil (#)	R	R	R	R	R	R
		Check level at every 1000 km or earlier and top up as required					
2	Engine oil filter element (#)	R	R	R	R	R	R
3	Inlet and exhaust valve clearance (**)		I&A	I&A	I&A	I&A	I&A
4	Spark plug	I	I	R	I	R	I

## PERIODICAL MAINTENANCE

SI. No.	DESCRIPTION	PERIODICAL MAINTENANCE (Whichever is earlier)					
		0.5	7.5	15	22.5	30	37.5
	km (x 1,000)	0.5	7.5	15	22.5	30	37.5
	miles (x 1,000)	0.3	4.66	9.32	13.98	18.64	23.3
	Months	1.5	12	24	36	48	60
5	HT lead for crack	I	I	I	I	I	I
6	Rubber hose, air filter to throttle body	I	I	I	I	I	I
7	Rubber hose, Inlet manifold / Adaptor	I	I	I	I	I	I
8	Evaporative Emission Equipment rubber hoses	I	I	I	I	I	I
9	Fuel filter - External			R		R	
10	Air filter element	C	R	R	R	R	R
		Clean / replace more frequently if operated in dusty condition					
11	Vent Pipe under air filter box	I	I	I	I	I	I

## PERIODICAL MAINTENANCE

SI. No.	DESCRIPTION	PERIODICAL MAINTENANCE (Whichever is earlier)					
		0.5	7.5	15	22.5	30	37.5
	km (x 1,000)	0.5	7.5	15	22.5	30	37.5
	miles (x 1,000)	0.3	4.66	9.32	13.98	18.64	23.3
	Months	1.5	12	24	36	48	60
12	Accelerator and throttle pulley cables free play	A	A	A	A	A	A
13	Clutch cable / lever free play	Adjust every 1000 km or earlier as required					
14	Hand levers pivot point	Lubricate every 1000 km or earlier as required					
15	Brake pads - Front and rear	I	I	I	I	I	I
16	Disc brake fluid level - Front and rear	I	I	R	I	R	I
17	Rear brake pedal and gear change pedal pivot	L	L	L	L	L	L
18	Brake hose and banjo bolt - Front and rear	I	I	I	I	I	I

## PERIODICAL MAINTENANCE

Sl. No.	DESCRIPTION	PERIODICAL MAINTENANCE (Whichever is earlier)					
		0.5	7.5	15	22.5	30	37.5
	km (x 1,000)	0.5	7.5	15	22.5	30	37.5
	miles (x 1,000)	0.3	4.66	9.32	13.98	18.64	23.3
	Months	1.5	12	24	36	48	60
19	Front Fork oil leak						
		Replace oil at every 60000 km or any work carried out whichever is earlier					
20	Steering tapper roller bearing Play						
21	Rear wheel drive chain	Lubricate and Adjust every 1000 km / Clean, Lubricate and Adjust every service or earlier as required					
22	Rear wheel cush rubbers						
23	Spokes tightness / Wheel rim run out front and rear (It is applicable for spokes wheel model)						

## PERIODICAL MAINTENANCE

SI. No.	DESCRIPTION	PERIODICAL MAINTENANCE (Whichever is earlier)					
		0.5	7.5	15	22.5	30	37.5
	km (x 1,000)	0.5	7.5	15	22.5	30	37.5
	miles (x 1,000)	0.3	4.66	9.32	13.98	18.64	23.3
	Months	1.5	12	24	36	48	60
24	Battery terminals (apply petroleum jelly)	I	I	I	I	I	I
25	Earth wire eyelet tightness		I	I	I	I	I
26	Tyre wear pattern front and rear	I	I	I	I	I	I
27	Pivot-Side stand, center stand	L	L	L	L	L	L
28	Rider and pillion foot rest pivot	L	L	L	L	L	L
29	All mounting fasteners in vehicle for tightness	I	I	I	I	I	I

I - Inspect (Clean, Adjust, lubricate or replace if necessary)

L - Lubricate

R - Replace

C - Clean

A : Adjust

---

## **PERIODICAL MAINTENANCE**

---

The maintenance schedule detailed here will help you to maintain your Royal Enfield motorcycle meticulously and to get along trouble free service.

The frequency of the maintenance must be shortened depending upon the severity of the driving condition. or if the motorcycle is used in a very dusty environment, severe climatic cold and hot conditions, bad roads, stagnant water, rainy season and at full throttle etc., Contact a nearest Royal Enfield Authorised Dealer / Service Centre for expert advice and to carry out the periodical maintenance.

(#) - After First service, Engine oil and Engine oil filter replacement is a mandatory at every 12 months even the vehicle has not covered the specified km.

(\*\*) - After First service, Valve clearance adjustment is a mandatory at every 12 months even the vehicle has not covered the specified km.

---

### **NOTE**

---

For Maintenance after 37,500 km, Please repeat the same frequency specified above, in consultation with a Royal Enfield Authorised Dealer / Service Centre.

---

## GENERAL WARRANTY TERMS AND CONDITIONS

---

Royal Enfield motorcycles ("Motorcycles") are manufactured by following best quality practices in respect of the material and workmanship. All motorcycles (irrespective of their country of registration) can avail limited warranty services from a Royal Enfield Authorised Dealer Workshop / Service Centre located in another country, In addition to its country of registration; and customers should refer to the terms and conditions mentioned under Borderless Warranty Policy.

**IMPORTANT:** Please make sure you have read and understood these terms and conditions

This warranty outlines the terms and conditions governing the Motorcycles warranty coverage obligations and exclusions only and not on the part of any Royal Enfield Authorised Dealer. Nothing in this document should be construed as a principle agent relationship between Royal Enfield and any of its Authorised Dealers or their staff. Royal Enfield warrants its Motorcycles to be free from manufacturing and material defects under normal use subject to the following conditions:

1. Warranty for any Motorcycle shall be in force until the expiry of 36 months from the date of the Sale of the motorcycle to the first owner and to any subsequent owners for the balance of the remaining period until the expiry of above mentioned warranty period.
2. In order to avail warranty benefits by second or subsequent owner, the second or subsequent owner should inform the nearest Royal Enfield Service Centre about the purchase of the motorcycle and shall fill in the requisite details in the form as requested by Authorized Royal Enfield Service Centre.
3. The warranty on any Motorcycle shall be applicable only if all the maintenance and services with respect to the said Motorcycle are availed by the owner(s) within the respective Warranty Period/kilometer ranges as per the schedule in the owner's manual from Royal Enfield Authorized Dealer/Service Centre.

---

## **GENERAL WARRANTY TERMS AND CONDITIONS**

---

4. During the warranty term, Royal Enfield's warranty obligations shall be limited only to repair or replace the faulty part(s) with a new part(s) only if such faulty part(s) on examination is deemed to have a manufacturing defect. Defective part(s) which have been replaced under the Warranty term shall become the sole property of Royal Enfield.
5. This warranty is expressly limited to the repair or replacement of the genuine parts with a manufacturing defect and is the sole remedy of warranty.
6. To the fullest extent permissible by applicable law, all other warranties of any kind, either express or implied, are disclaimed. The exclusion of implied warranties mentioned herein does not apply to the extent prohibited by any applicable law.
7. Warranty shall not apply to:
  - (a) Consumables including but not limited to oil, oil filter, brake fluid, coolant, fuel, grease etc. used during repair/ replacement are not covered and such consumables shall be chargeable to the customer.
  - (b) The customer assumes all the risk and liability arising out of his or her repairs to the Product or replacement parts thereto or arising out of his or her installation of replacement parts thereto. If any time during the warranty period, the Product or any part or parts thereof are removed, altered, tampered, adjusted, modified, dismantled, repaired or handled in any way whatsoever by any person or persons not authorized by the Company, this Policy shall immediately cease to be valid and become void initially and of no effect whatsoever.

---

## GENERAL WARRANTY TERMS AND CONDITIONS

---

- (c) Normal ageing (wear and tear), deterioration or rusting of plated parts, paints coat, rubber parts, soft items, glass items, plastic parts etc. Components like oil filter, air filter paper element, control cables, brake shoes/brake pads, clutch plates, drive chain & sprocket kit, steering ball races, electrical equipment, wiring harness etc., which are subjected to normal wear and tear. Failures occurred due to use of non-recommended grade lubricants, coolant, brake fluid, fork oil, fuel or improper level.
- (d) Damages due to use of non-genuine parts or accessories, lack of proper maintenance, incorrect riding habits. Damages to engine management system parts (like ECU, throttle body, sensors, etc.) due to tampering which affects the performance of the motorcycle. Parts damaged due to accidents, collision, neglect, abuse, mishandling, fire or any act of God etc.
- (e) Irregularities not recognised as affecting the quality or function of the motorcycle such as slight vibration, oil leakage, discoloration of exhaust pipe bend and cat region/silencer/soft or hard shock absorber etc.
- (f) Discoloration of exhaust pipe & silencer, as it is a natural process that will happen during usage.
- (g) Defects or damage arising from fitment of unauthorised accessories or parts like side cars, trailer hitches etc., or additional electrical loads.
- (h) Motorcycle serviced or repaired at unauthorised service centres.
- (i) Motorcycle used for competitions/racing/stage rallying/ /stunts//jumping/acrobatics etc. or similar activities as Motorcycles are not designed or intended for such purpose or usage

---

## GENERAL WARRANTY TERMS AND CONDITIONS

---

- (j) Electrical component like bulbs, fuses etc., and electronic components failure including ECU due to repairs by arc welding.
  - (k) Motorcycle found with tampering/drilling/welding mark on any part of the frame.
  - (l) Normal maintenance operations like adjustment of brakes, cleaning fuel system, engine tune-up and other such adjustments.
  - (m) Oxidization of buffed/painted/powder coated items etc
  - (n) Any damage resulting due to any force major event including, without limitation, any act of war, act of God or nature, earthquake, hurricanes, tornadoes, flood, fire or other similar casualty, riot, terrorism etc.
  - (o) Any damage, failure or loss caused by improper - assembly, maintenance, storage or use of the motorcycle or parts thereof.
8. Use only Royal Enfield approved parts and accessories (as applicable). Use of other manufacturer's performance parts will void your motorcycle warranty.
9. The warranty will be null and void if :
- (a) The Motorcycle is used in a manner other than for recreation or transportation; or
  - (b) The Motorcycle is modified in any manner; or
  - (c) The serial number /identification code is deleted, defaced, altered, effaced or removed.

---

## GENERAL WARRANTY TERMS AND CONDITIONS

---

10. The following are specifically excluded from the terms and provisions of this warranty:

- (a) Labour costs for fitting replacement parts under this warranty unless the original warranted part or accessory was fitted by any Royal Enfield Authorised Dealer.
- (b) Any RE accessory modified for use or installed on a RE Motorcycle model for which it is not designed or recommended.

11. Royal Enfield reserves the right to finally decide on all warranty claims.

12. RE reserves the right to make changes in the design of the motorcycle models without any obligation to install these changes on previously supplied Motorcycles.

13. Royal Enfield may, as a result of the purchase of motorcycle/ its parts and prescribed accessories/ servicing of motorcycles/ claiming of any applicable warranty during the Warranty Period; by you (i.e., customer), receive sensitive and/or personal data and information relating to you or third parties associated with you (such as your spouse or family members, or relatives). Such data may be received from you, or from other sources, and some sensitive/personal data may be recorded directly or indirectly by internal security systems of Royal Enfield or by other means. Royal Enfield may process such data for relevant and limited purposes and in this regard, you expressly consent to the following:

- (a) The processing of sensitive personal data and information pertaining to you or the third parties associated with you, by Royal Enfield.
- (b) The collection and processing of sensitive personal data and information about you for limited purposes;

---

## GENERAL WARRANTY TERMS AND CONDITIONS

---

(c) The worldwide transfer of sensitive personal data and information pertaining to you or the third parties associated with you, held by Royal Enfield to its service providers, dealers, suppliers, advisors and offices of Royal Enfield's worldwide organization and to third parties where disclosure to such third parties is required in the normal course of business or by law; and use of the your personal images and voices in marketing material, videos, etc.

In the event you wish to withdraw the express consent provided in point 13 above, you agree to send an email at [support@royalenfield.com](mailto:support@royalenfield.com) specifying that you wish to withdraw such consent and RE shall accordingly delete all the sensitive and/or personal data pertaining to you, as available in the records of RE within a reasonable time, in accordance with applicable laws.

14. The exclusive remedy for breach of this warranty shall be, at Royal Enfield's option, repair or replacement of any defective materials, components, or products. The remedies set forth in this warranty are the only remedies available to any person for breach of this warranty. RE shall have no liability to any person for incidental, consequential or special damages of any description, whether arising out of express or implied warranty or any other contract, negligence, or other tort or otherwise. This exclusion of consequential, incidental, and special damages is independent from and shall survive any finding that the exclusive remedy failed of its essential purpose.
15. Disclaimer of Warranties: Except for warranties expressly made herein, RE makes no warranties or representations express or implied, either in fact or by operation of law, statutory or otherwise.
16. The General Warranty shall be governed by the laws of India and you hereby consent to the exclusive jurisdiction and venue of courts in New Delhi, India.

---

## **BORDERLESS WARRANTY TERMS AND CONDITIONS**

---

RE Borderless Warranty (not applicable for motorcycles exported from one country to another under personal imports) is subject to following conditions.



1. The rider should carry maintenance and service records, proof of ownership and Motorcycle registration document (original / photocopy / soft copy) for verification by the Royal Enfield Authorized Dealer.
2. The periodic maintenance services have been availed in the respective period/kilometer ranges as per the schedule in the owner's manual from a Royal Enfield Authorized Dealer Workshop/Service Centre.
3. Royal Enfield Authorized Dealer Workshop's / Service Centre's obligations shall be limited to repairing/replacing the genuine part(s) of the motorcycle free of cost only if the part(s), on examination, is deemed to have a manufacturing defect. Defective part(s) which have been replaced will become the sole property of Royal Enfield after due verification.
4. The rider shall transport the motorcycle to/from a Royal Enfield Authorized Dealer Workshop / Service Centre on his own cost and means.

---

## **BORDERLESS WARRANTY TERMS AND CONDITIONS**

---

5. Royal Enfield Authorized Dealer Workshop / Service Centre shall work towards delivering the motorcycle at the best possible time. However, servicing time /period may be longer than usual / extended subject to the availability of required emission / country specific homologated spare parts in the given country.
6. Royal Enfield Authorized Dealer Workshop / Service Centre shall take utmost care while disassembly and reassembly or removal and refitment of non-genuine spare parts and accessories including electrical or electronics items like fog lamps, high power lamps, aftermarket horns, mobile phone charger, navigator etc. However, the Royal Enfield Authorized Dealer Workshop / Service Center shall not take responsibility for any breakage / damage / malfunction / inability to refit due to non-availability of special tools / skills etc for assembling the non-genuine spare parts and or accessories while servicing / repairing the motorcycle.
7. Neither RE nor any Royal Enfield Authorized Dealers and / or its distributors shall be held liable for any loss including loss of time / money due to delay in servicing / repairing the motorcycle and the rider is responsible to make his own arrangement for accommodation, further travel etc in such cases.
8. In the event the motorcycle is required to be towed to another workshop for further repair or to the rider's home country as repatriation, it shall be done at the rider's own expenses and risk.
9. The remaining Terms and Conditions shall be the same as for General Warranty.
10. The Borderless Warranty shall be governed by the laws of India and you hereby consent to the exclusive jurisdiction and venue of courts in New Delhi, India.

For updated Authorized Service network, visit <https://www.royalenfield.com/in/en/locate-us/service-centres>. If you are traveling abroad and require warranty assistance or advice from a Royal Enfield Authorized Dealer, visit [www.royalenfield.com/borderless-warranty/](http://www.royalenfield.com/borderless-warranty/) for more information.

---

## **CUSTOMER'S RESPONSIBILITY**

---

1. The customer shall take all possible steps to prevent further damage as soon as any problem is apparent and within a reasonable time from such damage, notify Royal Enfield Authorized Dealer / Service Centre of such damage.
2. By purchasing any Motorcycle produced by RE, the customer assumes responsibility to ascertain and follow all applicable laws, and international laws in having, owning, using, or transporting any Motorcycle. The customer expressly agrees to indemnify and hold harmless RE for all claims resulting directly or indirectly from the purchase, ownership, transportation, or use of the Motorcycle in violation of applicable laws. RE is not liable for misuse of any Motorcycle purchased from an authorised Dealer / Distributor.

---

## **LIMITATION OF LIABILITY**

---

Notwithstanding anything contrary contained in this policy, Royal Enfield's liability under this warranty is limited to the repair the defective Motorcycle, at its sole discretion. In no event, shall Royal Enfield be liable for any indirect, special or consequential or incidental damages or for injury to person or property, or for loss of time or for any commercial loss, or inconvenience or any other incidental or punitive or consequential loss arising from the use of Motorcycles.

---

## **EMISSION WARRANTY**

---

Royal Enfield certifies that the following warranty is applicable to those components liable to affect the emission of the gaseous pollutants in its range of motorcycle, in normal use to which it may be subjected to.

This emission warranty is valid for 40,000 km/3 years from the date of first sale whichever earlier, to the first customer and is in addition to and parallel to the warranty policy, conditions and obligations laid down in the Owner's Manual.

Royal Enfield further warrants that if on examination by its Royal Enfield Authorised Service Centre, the motorcycle fails to meet the specified emission standards, then the Authorised Service Centre shall take necessary corrective measures and shall, at its sole discretion, repair or replace free of charge components of the emission control system to meet the required emission standards.

The method/s of examination to determine the warranty conditions of the emission warranty related components will be at the sole discretion of Royal Enfield and/or our Authorised Service Centre and results of such examination will be final and binding. If on examination the warranty conditions of the part/s is/are not established, Royal Enfield will have the right to charge all, or part of the cost of such examination to the customer in addition to the cost of the components.

In case of acceptance of the component/s under Emission warranty, Royal Enfield will replace free of charge the component/s as required. However, the consumables like fuel, lubricants, solvents, etc. shall be chargeable to the customer as per actuals.

---

## **EMISSION WARRANTY**

---

In case any of the components covered under emission warranty or the associated parts are not independently replaceable. Royal Enfield will have the sole discretion to replace either the entire assembly or parts of the assembly through suitable repairs.

Royal Enfield reserves the right to carry out necessary consequential repairs to the motorcycle or replace any part, in addition to the repair or replacement of the components covered under emission warranty. to establish compliance to in use emission standards. Such repairs/replacements will be chargeable to the customer.

All parts removed for replacement under warranty will become the property of Royal Enfield.

Royal Enfield will not be responsible for the cost of transportation of the motorcycle to the nearest Authorised Service Centre or for any loss due to non availability of the motorcycle during the period of examination and repairs by Royal Enfield and/or their Authorised Service Centre.

Royal Enfield will not be responsible for any penalties that may be charged by statutory authorities on account of failure to comply with the in-use emission standards.

The cost incurred to check emission of the motorcycle will have to be borne by the customer.

Emission warranty will be applicable irrespective of the change of ownership of the motorcycle provided all the conditions as laid down in this document are met from the date of original sale of the motorcycle.

---

# **EMISSION WARRANTY**

---

---

## **THE WARRANTY SHALL APPLY IF THE CUSTOMER**

---

- Observes all the important instructions and any other precautions listed in the owner's manual.
- Under all circumstances uses lubricants and fuel as recommended by Royal Enfield.
- Regularly obtains and carries out maintenance in accordance with Royal Enfield guidelines and enters the details in the log book.
- Immediately approaches the nearest RE Authorised Dealer/Service centre upon discovery of failure to comply with the emission standard in spite of having maintained and used the motorcycle in accordance with the instructions in the owner's manual and having carried out such repairs and adjustments as may be required with a view to establish such compliance.
- Production of a valid pollution under control certificate is necessary to claim emission warranty.
- Produces the owner's manual and Log book for verification details.
- Produces receipts covering maintenance of the motorcycle as specified in the owner's manual from the date of original purchase of the motorcycle.
- Produces valid certificate of insurance and RTO Registration Certificate (R.C. Book).

---

# EMISSION WARRANTY

---

---

## THE EMISSION WARRANTY SHALL NOT APPLY IF

---

- A valid "Pollution under control" certificate is not produced.
- The motorcycle is not serviced by RE Authorised Dealer/Service Centre as per the service schedule described in the maintenance chart.
- The motorcycle has been subjected to abnormal use, abuse, neglect and improper maintenance or has met with an accident.
- Replacement parts not specified and approved by Royal Enfield have been used.
- The motorcycle, or parts there of, has been altered, tampered with or modified or replaced in an unauthorised manner.
- The odometer is not functioning or the odometer and/or its reading has been changed/tampered with, so that the actual distance covered cannot be readily determined.
- The motorcycle has been used for competitions, races and rallies or for the purpose of establishing records.
- On examination by Royal Enfield or its Authorised Dealer/Service Centre if the motorcycle shows that any of the conditions stipulated in the owner's manual with regard to use and maintenance have been violated.
- The motorcycle has been run on adulterated/leaded fuel or lubricant other than those specified by Royal Enfield in the Owner's manual or any other document given to the customer at the time of sale of the motorcycle.

---

## **EMISSION WARRANTY**

---

- The emission related components are tampered with.
- All service and parts related bills and vouchers incurred during the tenure of the emission warranty is not produced.
- All maintenance activities carried out on the motorcycle during the tenure of the emission warranty are not entered in the log book.

---

## **TIPS TO BE ON THE RIGHT SIDE OF LAW**

---

- Always get your motorcycle checked to meet the emission regulations through an authorised emission checking centre.
- Always carry a valid "Pollution Under Control" certificate with you, as and if applicable by law.

---

## **TIPS TO REDUCE POLLUTION**

---

- Ensure that the periodical maintenance is carried out as stipulated in the owner's manual through a Royal Enfield Authorised Service Centre.
- Use only Unleaded petrol (91 RON or higher) from reputed fuel pumps.
- Ensure the fuel used is not adulterated.
- Use correct spark plug as recommended in the owner's manual.
- Use lubricants as per recommendations given on grade/brand in the owner's manual.

---

## **EVAPORATIVE EMISSION CONTROL SYSTEM WARRANTY**

---

The following warranty applies to the evaporative emission control system.

Royal Enfield Motors warrants the first owner and each subsequent owner, that this motorcycle is designed and built so as to conform, at the time of sale, with applicable regulations specified by the evaporative emission control system related parts fitted to this motorcycle are free from defects in materials and workmanship which may cause this motorcycle not to meet applicable regulations period of 24 Months from the date of first use of the motorcycle.

The Warranty period shall begin either on the date the motorcycle is delivered to the first retail purchaser or from the first date the motorcycle is used as a demonstrator or as a display and/or trial motorcycle.

---

### **THE FOLLOWING ARE NOT COVERED BY THE EVAPORATIVE EMISSION CONTROL SYSTEM WARRANTY**

---

1. Failures which may arise as a result of misuse, alterations, accidents or non performance of routine maintenance, as specified in the Owner's Manual.

---

## **EVAPORATIVE EMISSION CONTROL SYSTEM WARRANTY**

---

2. Replacing, removing or modifying any portion of the EVAPORATIVE EMISSION CONTROL SYSTEM (consisting of fuel tank, fuel tank cap, canister, purge valve, throttle body, vapor hoses, fuel hoses and hose connectors) with parts not certified by Royal Enfield.
3. Loss of time, inconvenience, loss of motorcycle use or any other consequential loss or damages.
4. Any motorcycle in which the Odometer has been tampered with OR the speedo cable has been disconnected for any reason or is broken and not replaced immediately, due to which the exact distance covered cannot be determined.
5. Normal aging of parts such as fuel hoses, vapor hoses, gaskets and rubber components.

---

## **RECOMMENDATIONS FOR REQUIRED MAINTENANCE**

---

It is recommended that the routine maintenance of the motorcycle be carried out at specified intervals and any maintenance to the evaporative emission control systems should be performed only by an Authorised Royal Enfield Service Centre and using only genuine Royal Enfield spare parts.

---

## RADIO TYPE APPROVAL (If fitted)

---

**TRIPPER / NAVIGATION DISPLAY UNIT**

---

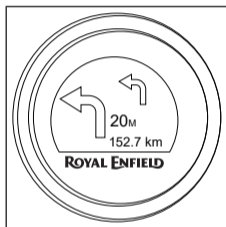

**UNITED KINGDOM (UK)**

---

**UK  
CA**

**EUROPEAN UNION (EU)**

---

**CE**

Max. RF power: 4 dBm and Operation frequency range: 2408 to 2480 MHz

Hereby, **Visteon Corporation** declares that the radio equipment type **JDCP** is in compliance with Directive 2014/53/EU. The full text of the EU declaration of conformity is available at the following internet address:  
[www.visteondocs.com](http://www.visteondocs.com).

---

## SERVICE/MAINTENANCE RECORD

---

S.No.	Type of service	Schedule	Date	Job card No.	km	Dealer code	Brief details of service

---

# WIRING DIAGRAM

---

---

## DISCLAIMER

---

It is recommended that the wiring circuit repair and any other electrical rework should be performed only by an Authorized Royal Enfield Service Centre, failure to adhere this may cause damage to electrical systems and render the warranty of the products as void.







**ROYAL ENFIELD**

ROYALENFIELD.COM



RAM00723/A

Part No. RAM00723/A

Edition: 16th December 2025