

ROYAL ENFIELD OWNER'S MANUAL

UK ENGLISH



ABS
DUAL CHANNEL

FOREWORD

Welcome to the world of pure motorcycling. A brand-new HNTR 350 is now all yours.

At its heart is a fuel-injected, long-stroke 349cc J-engine that delivers a smoother ride, higher RPM and dollops of torque. This comes wrapped in a compact, muscular frame, matched with a super-manoeuverable set of wheels and controls. The result: a fun, effortlessly manoeuvrable machine that delivers a stylish, city- friendly dose of exhilaration every time you ride it.

This manual has been designed to help you to operate and maintain your HNTR 350 the right way, allowing you to get the most out of your motorcycle.

To ensure your HNTR 350 always gets the best of care, please avail the services of your nearest Royal Enfield Authorised Service Centre. Do read through the terms and conditions of warranty and other useful information given in this manual before you head out.

Keep Hunting!

NOTICE

All information in this manual is based on the latest product information available at the time of publication. Due to continuous improvements, there may be differences between the information provided in this manual and information related to your motorcycle.

Always consult an authorized Royal Enfield dealer for the latest specifications, features etc. Royal Enfield reserves the right to make production changes at any time without prior notice and without incurring any obligation to make the same or similar changes to a motorcycle previously built or sold. All images shown are for reference to explain and need not to be exactly the same on the model you own. Accessories and features may not be part of standard equipment. Technical specifications are subject to change without prior notice at the sole discretion of Royal Enfield.

Please take care while disassembling and assembling the seats, and sheet metal parts, as any sharp edges will lead to injuries.

“© Copyright 2025 Royal Enfield (A unit of Eicher Motors Ltd.). All Rights Reserved. No part of this manual shall be copied, distributed or otherwise dealt without the express permission in writing from Royal Enfield”.

To access further details on the product's Repair and Maintenance Information, visit <https://serviceinfo.royalenfield.com> through a paid subscription.

DISCLAIMER

1. Do not polish matt finished paint surface in your motorcycle as it will increase the gloss level.
2. Wash the painted parts only with plain water and do not use any strong solvents cleaning agents or detergents.
3. Scratches, if happens on the matt finish parts cannot be touched up and corrected / removed.
4. Warranty is not applicable for any matt finished painted parts of the motorcycle.

NOTE

■ This motorcycle meets the Euro 5+ norms.

Part No. RAM01203/A / 19th May 2026

CONTENTS

Safety definitions	4	Long trip precautions	96
Personal and motorcycle information.....	5	Rear suspension setting	97
Safe riding tips / guidelines	6	Cleaning procedure	99
Rules of the road	10	Storage precautions	101
Accessories and luggage	12	Troubleshooting.....	102
Technical specifications	14	Environment care.....	104
Recommended lubricants	19	Periodical maintenance.....	105
Motorcycle identification numbers.....	20	General warranty terms and conditions.....	110
Location of key parts.....	21	Borderless warranty terms and conditions	117
Operation of controls	24	Customer's responsibility.....	119
Warning indications and safety systems.....	50	Limitation of liability.....	119
Pre-operational checks	54	Emission control system warranty.....	120
Running in period	55	Evaporative emission control system warranty.....	125
Starting.....	56	Radio type approval	126
Gear shifting, riding and stopping.....	60	Service / Maintenance record	127
Parking	63	Wiring diagram	128
Tool kit	65	Notes	129
Minor maintenance tips	66		

SAFETY DEFINITIONS

The information given under the titles: Warning, Caution and Note are for your safety and for the care and safety to your motorcycle and others. Please read these carefully and if disregarded may result in injury to yourself or others and damages to the motorcycle.



WARNING

Indicates a potentially hazardous situation. Disregarding this message may result in injury to rider or other persons.

CAUTION

This message, if disregarded, may result in damage to the motorcycle.

NOTE

Indicates important and useful messages for better understanding.

PERSONAL AND MOTORCYCLE INFORMATION

Name										
Door No. / Street										
Locality / Town										
City								Country		
Contact No.	Res:							Off:		
	Mobile:							Email:		
Licence No.								Valid till:		
Model								Color:		
Engine No.										
VIN. No.										
Tyre Make	Front:							Rear:		
Tyre Nos.	Front:							Rear:		
Battery make							Battery No.			
Sold by										
Date of Sale										

SAFE RIDING TIPS / GUIDELINES

- Before operating your new motorcycle, we request you to carefully read and follow the operating and maintenance instructions detailed in this manual for the safety of your own, your motorcycle and also that of others.
- Know and adhere to the rules of the road with respect to your driving country.
- Before starting the motorcycle, check for proper operation of brakes, clutch, gear shifter, handle bar controls, tyre pressures, fuel and oil levels, etc.
- Use only genuine Royal Enfield spare parts and approved accessories. Use of other manufacturer's parts may affect the performance of your motorcycle and render the motorcycle void of warranty. Visit your Royal Enfield Authorised Service Centre for details.
- Whenever refueling your motorcycle, please exercise utmost caution and carefully observe the following guidelines.
 - ★ Switch "OFF" mobile phones and other hand held electronic devices.
 - ★ Do not smoke and please ensure that there are no open flames or sparks near the motorcycle, when refueling or servicing the fuel system.
 - ★ Refuel in a well ventilated area with the engine turned off condition.
 - ★ Open the fuel tank cap slowly.
 - ★ Do not fill the fuel in tank to its brim. Please fill fuel till the bottom of anti splash plate, so as to leave sufficient air space in the fuel tank to allow for fuel expansion.

SAFE RIDING TIPS / GUIDELINES



WARNING

Royal Enfield cautions you against the use of certain non-standard parts such as aftermarket and custom made extended front forks or suspensions, which may adversely affect performance and handling. Removing or altering original parts may adversely affect performance and could result in accident.

- A new motorcycle must be operated according to the special running-in-procedure. See running-in-procedure mentioned in respective section.
- Operate motorcycle only at moderate speeds and out of traffic until you have become thoroughly familiar with its operation and handling characteristics under all conditions.

- Do not exceed the legal speed limit or ride too fast for existing conditions. Always reduce speed when poor riding conditions exist. High speed increases the influence of any other condition affecting stability and increases the possibility of loss of control.

NOTE

If you are an inexperienced rider we recommend that you obtain formal training on correct motorcycle riding techniques and become thoroughly familiar with the operation of your motorcycle. New riders should gain experience under various conditions while driving at moderate speeds. Pay strict attention to road surfaces and wind conditions. Any motorcycle may be subject to the following up-setting forces:

- ★ Wind blasts from passing vehicles.
- ★ Rough or uneven road surfaces.

SAFE RIDING TIPS / GUIDELINES

★ Slippery road surfaces.

These forces may affect the handling characteristics of your motorcycle. If this happens, reduce speed of the motorcycle to a controlled condition. Do not apply brake abruptly.

- Operate your motorcycle defensively. Remember that a motorcycle does not afford the same protection as an automobile in an accident. One of the most common accident situations occurs when the rider / driver of the other motorcycle / vehicle fails to see or recognise a motorcycle and turns into the oncoming motorcyclist.
- Wear an approved helmet, clothing and footwear suited for riding a motorcycle. Bright / light colours are best for greater visibility in traffic, especially at night. Avoid loose, flowing garments and scarves.
- When carrying a pillion rider, it is your responsibility instruct them on proper riding procedures.

- Do not allow other individuals, under any circumstances, to operate your motorcycle unless you know they are experienced, licensed riders and are thoroughly familiar with the operating conditions of your motorcycle.



WARNING

- Regularly inspect shock absorbers and front forks and look for leaks. Replace worn out parts. Worn out parts can adversely affect stability and handling.
- Exhaust gas contains poisonous carbon monoxide and chemicals, known to cause cancer, birth defects or other reproductive defects, durability / longevity operation of your motorcycle.
- For your personal welfare, all the listed service and maintenance recommendations should be performed. Lack of regular maintenance at the suggested intervals may affect the safe/durability/longevity operation of your motorcycle.

SAFE RIDING TIPS / GUIDELINES

- Avoid any contact with the exhaust system when hot. Wear clothing that will completely cover the legs while riding. The exhaust system gets very hot when the engine is running and remains too hot to touch, even after the engine is turned OFF. Failure to wear proper or protective clothing could result in serious injury.
- Motorcycle batteries contain lead, acids and chemicals known to cause cancer, birth defects or other reproductive harm. Exercise extreme caution while handling a battery, wash hands thoroughly whenever a battery is handled.
- Consult your Royal Enfield Authorised Service Centre regarding any questions or problems that occur in the operation of your motorcycle. Failure to do so may aggravate an initial problem, cause costly repairs and jeopardize your personal safety.
- Do not tow a motorcycle. The steering and handling of the towed motorcycle will be impaired due to the force of the towline. If a motorcycle must be transported, use a truck or a trailer.
- Do not pull a trailer behind a motorcycle. Towing a trailer may cause reduced braking efficiency, tyre overloading and unstable handling, as it may cause loss of control of the motorcycle in the front, leading to an accident.

RULES OF THE ROAD

- Be sure your number plate is installed in the position specified by law and it is clearly visible at all times.
- Ride at a safe speed that is consistent with the type of road surface you are on. Pay strict attention while riding on the following surfaces:
 - ★ Dusty
 - ★ Oily
 - ★ Icy
 - ★ Wet
 - ★ Sand
- Watch for loose debris, such as leaves, slippery substances or gravel that can hamper the stability of your motorcycle.
- Keep to the correct side of the road center line, when meeting oncoming vehicles.
- Actuate your turn signals and exercise caution when passing other vehicles going in the same direction. Never try to pass another vehicle going in the same direction at street intersections, on curves, or when going up or down a hill.
- At street intersection give the right-of-way to the motorcycle on your left or right. Do not presume you have the right-of-way.
- Adhere to the rules of the road with respect to your country when preparing to stop, turn or pass. While turning either right or left, watch for pedestrians, animals, as well as other vehicles.
- All traffic signs, including manual controls at intersections, should be obeyed promptly. Slow down at traffic signs near schools and caution signs at rail road crossings.
- When intending to turn, signal at least 100 feet (30.5 m) before reaching the turning. Be close to the center line (unless local rules require otherwise), slow down and then turn carefully.
- Never jump a traffic light. When a change is imminent from go to stop (or vice versa) at intersections, slow down and wait for the light to change to green. Never run through a yellow or red traffic light.

RULES OF THE ROAD

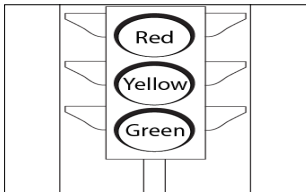

- Do not leave the curb or parking area without signaling. Be sure your way is clear to enter moving traffic. A moving line of traffic always has the right-of-way.
- When parking the motorcycle, park on a firm and flat surface to prevent it from falling over.
- Protect your motorcycle against theft. After parking your motorcycle, ensure that the steering head is locked and then remove the ignition key.

SIDE VIEW MIRRORS

Your motorcycle is equipped with convex mirrors and have a curved surface.

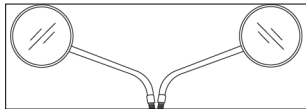

This type of mirror is designed to give a much wider view of the rear than a normal flat mirror. However, vehicles and other objects seen in this type of mirror will look smaller and farther away than when seen in a flat mirror. Use care when judging the size or distance of vehicles / objects seen in these mirrors. Use the tool available in tool kit to loosen and adjust the side mirrors.

NOTE

To establish the relative distance of vehicles / objects behind your motorcycle through the mirrors, adjust each mirror in such a way that a small portion of your shoulder is visible and a large portion behind your motorcycle is seen clearly with reference to your riding posture.

ACCESSORIES AND LUGGAGE

Royal Enfield offers a range of Genuine Motorcycle Accessories that have been fully approved and extensively tested alongside the motorcycle.

Therefore, the rider must be responsible for safe operation of the motorcycle when installing accessories or carrying additional weight.

Please adhere to the following guidelines when carrying a pillion, luggage or when fitting any accessories.

- Do not exceed 110 km/h when riding solo, carrying a pillion or payload on an accessory equipped motorcycle.
- Keep luggage weight concentrated close to the motorcycle and as low as possible; this minimizes sudden shift in the motorcycle's center of gravity.
- Distribute weight evenly on both sides of the motorcycle.

- Do not load bulky items behind the rider or add weight to the handlebars or front forks.
- Re-check the luggage periodically to ensure it is secured and will not shift while riding. Accessories mounted loosely may affect the riding of the motorcycle and affect the handling and stability of the motorcycle.
- Large surfaces such as fairings, windshields, backrests and luggage racks can adversely affect handling of the motorcycle. Use only Royal Enfield genuine motorcycle accessories which are model specific and follow installation procedure.

ACCESSORIES AND LUGGAGE



WARNING

- Do not load weight or install accessories incorrectly on the motorcycle. Doing so may affect the motorcycle's stability, handling characteristics and safe operation and could result in an accident causing serious injury or loss of life.
- Royal Enfield offers a range of Genuine Motorcycle Accessories that have been fully approved and extensively tested alongside the motorcycle.
- Royal Enfield cautions you against use of nonstandard parts such as aftermarket and custom made extended front forks which may adversely affect the performance and handling of the motorcycle. Removing or altering original parts may adversely affect the performance of the motorcycle, causing an accident, which could result in serious injury or loss of life.
- Do not ignore model / design specifications. Doing so constitutes both motorcycle and accessories misuse which may adversely affect the handling and performance of the motorcycle causing an accident, which could result in serious injury or loss of life.

TECHNICAL SPECIFICATIONS

ENGINE

Engine type	Single cylinder, 4 stroke, Air-Oil cooled
Bore	72 mm
Stroke	85.8 mm
Engine capacity.....	349 cc
Compression ratio	9.5:1
Max power	14.87 kW@ 6100 rpm
Max torque	27 Nm @ 4000 rpm
Idle RPM	1050 ± 100 rpm
Starting.....	Electric start
Air cleaner	Paper element

Lubrication Wet sump, forced lubrication

IGNITION SYSTEM

Ignition type.....	Electronic Fuel Injection (EFI) (Conti)
Spark plug.....	YR7MES / M12 Bosch RER6YCA / M12 Champion
Spark plug gap	0.7 to 0.8 mm

TECHNICAL SPECIFICATIONS

TRANSMISSION

Clutch	Wet, multi-plates (Assist & Slipper) clutch
Primary drive	Gear
Primary ratio.....	2.313:1
Gear box	5 Speed constant mesh
Gear ratio.....	1 st 2.615:1 2 nd 1.706:1 3 rd 1.300:1 4 th 1.040:1 5 th 0.875:1
Final drive.....	Chain

Secondary sprocket ratio ... 2.800:1

Drive chain links 104 links

CHASSIS

Frame..... Twin downtube spine frame

Suspension

Front..... Telescopic, 41 mm forks,
130 mm travel

Rear Twin tube emulsion shock
absorbers with 6 step
adjustable preload, 100 mm
travel

Brakes

Front disc..... 300 mm disc with twin piston
floating caliper

Rear disc 270 mm disc, single piston
floating caliper

ABS Dual channel

TECHNICAL SPECIFICATIONS

Tyre Size

Type of Tyre	Standard type
Front	Alloy wheel - 110/70-17" 54P (Tubeless tyre)
Rear	Alloy wheel - 140/70-17" 66P (Tubeless tyre)

Tyre pressure

Tyre pressure	Solo	With pillion
Front	29 psi	29 psi
Rear	32 psi	36 psi

Steering lock..... Integrated with ignition lock
43(deg)

Fuel type..... E5/E10 Unleaded gasoline

Fuel tank capacity..... 13* L

Low fuel warning..... 4* L (Including dead stock)

Fuel dead stock 1.5 ± 0.5* L

* The above values are approximate and the actual fuel filling capacity will vary from the values mentioned.

TECHNICAL SPECIFICATIONS

ELECTRICALS

Generation.....	Alternator (ACG)
Battery.....	12V - 8 Ah VRLA / 12 V - 10 Ah VRLA (maintenance free)
Starter motor.....	12V - 0.7 kW
Head lamp.....	HB/LB: 12V, 16.5W/11W (LED) with integrated FPL 12V, 1.65W (LED)
Brake/Tail lamp	13.5 V, 0.5 W/4.8 W (LED)
Instrument cluster	Digital cluster with main LCD
Turn signal.....	12 V, 10 W x 2 nos
Hazard warning.....	12 V - 10 W x 4 nos
Horn.....	Single tone - 2.5 A
Charger port.	Type C fast charger 5V/9V, 3A based on mobile demand



WARNING

Using bulbs/other electrical gadgets other than specified rating may lead to overloading/erratic behaviour/premature failure of electrical system. Modifications on the motorcycle which are not approved by Royal Enfield may not only render the warranty void, but also affect performance of the motorcycle.

TECHNICAL SPECIFICATIONS

DIMENSIONS

Length	2100 mm
Width.....	800 mm
Wheel base.....	1370 mm
Ground clearance	160 mm
Total Height.....	1055 mm
Seat height.....	790 mm

WEIGHTS

Kerb weight (with 90% fuel & Oil)	181 kg
Gross vehicle weight	360 kg

NOTE

- Values / Dimensions given above are for your guidance only.
- In view of continuous improvements being done on our products, the specifications are likely to change without prior notice.
- Do not use the vehicle beyond the allowed gross weight. The suspensions and tyres are designed to perform only to the maximum gross vehicle weight.

RECOMMENDED LUBRICANTS

ENGINE OIL		FRONT FORK OIL	BRAKE FLUID
Grade	SAE 15W 50 API SL grade JASO MA2 semi synthetic	Royal Enfield fork oil - SS8	DOT 4*
Capacity	Refill: 1.7 L Dry fill: 2.2 L	452 ± 2.5 cc/leg	Front: 87ml Rear: 54 ml

CAUTION

Use of wrong oil grade will reduce the life of the moving parts and seriously affect performance.

* Do not mix DOT 4 & other brake fluids together

NOTE

1. Recommendation subject to change without notice.
2. The above values are approximate and the actual capacity will vary.

MOTORCYCLE IDENTIFICATION NUMBERS

FRAME NUMBER

The VIN is a 17 digit number punched on the right side steering head tube in the form of label.

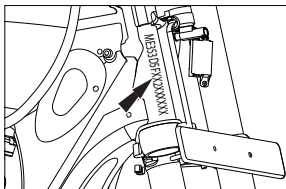

ENGINE NUMBER

Identification of the engine serial number and its production details. It is illegal to tamper with the engine number as it is the only means of identifications of the engine.

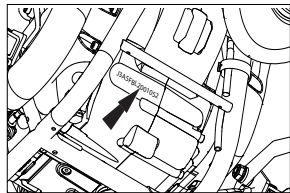

CAUTION

It is illegal to tamper with or alter the VIN/Engine numbers of the motorcycle as it will not only be against the law but will render the vehicle registration and warranty void.

LOCATION OF KEY PARTS

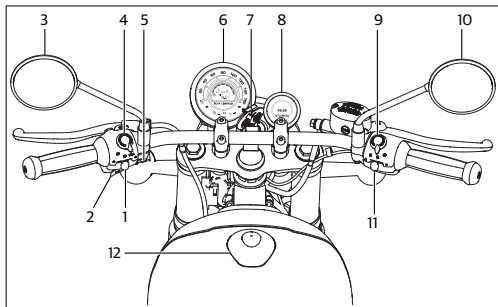

1. Turn signal switch
2. Horn button
3. Rear view mirror left side
4. High beam/Low beam switch
5. Fast charging port
6. Instrument cluster
7. Ignition key
8. Tripper (If fitted)
9. Electric start switch / Kill switch
10. Rear view mirror right side
11. Hazard switch
12. Fuel tank cap

LOCATION OF KEY PARTS

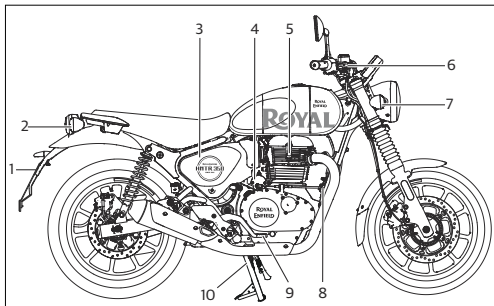

1. License Plate Illuminator
2. Right trafficator rear
3. Right side panel
4. Starter motor
5. Spark plug
6. Brake lever front
7. Right trafficator front
8. Horn
9. Brake pedal
10. Center stand

LOCATION OF KEY PARTS

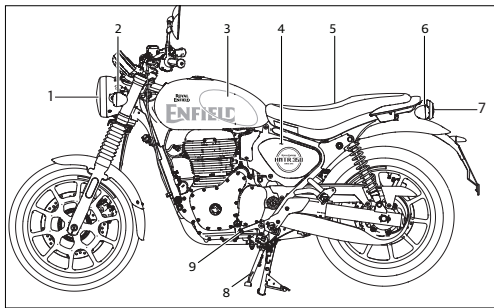

1. Head Lamp
2. Left trafficator front
3. Fuel tank
4. Left side panel
5. Seat
6. Left trafficator rear
7. Tail Lamp
8. Side stand
9. Gear change pedal

OPERATION OF CONTROLS

IGNITION KEY



"OFF"



"ON"

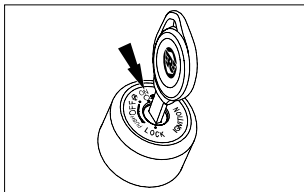

NOTE

- Key can be removed only if ignition is in OFF or steering is locked.

- Key is common for ignition, petrol tank lock, steering lock and right side panel.
- Key can be removed from fuel tank and right side panel only in locked position from the key slots.



WARNING

- Do not switch OFF ignition while riding the motorcycle.
- Doing so can cause a potential accident, resulting in serious injury to both rider and other road users, besides causing severe damage to the motorcycle.

STEERING LOCK

- Turn the handle bar to extreme left position.
- Push the key inside at OFF position, press and further turn to anticlockwise direction to lock the steering system.
- Turn the key in the clockwise direction to unlock the steering.

OPERATION OF CONTROLS

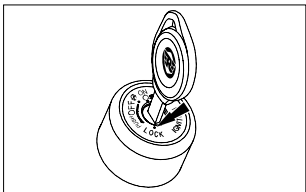

FUEL TANK CAP

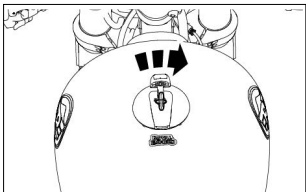

- Slide the key flap on fuel tank cap and insert key.

- Turn key clockwise to open.
- Press cap to lock with key in position.
- Remove key from cap and close flap.



WARNING

- Do not overfill the fuel tank.
- Fill fuel only till the bottom of anti splash plate.
- Over filling may result in fuel entering the EVAP canister and may damage the evaporative emission system.

CAUTION

- Gasoline vapour is highly explosive. Please ensure there are no open flames or sparks nearby while refuelling and fill fuel only in a well ventilated area.
- Please ensure gasoline does not spill on painted surfaces. In case fuel spills over the painted surfaces wipe it off immediately as it may leave a permanent stain.
- Do not smoke while refuelling or when fuel tank cap is open.

OPERATION OF CONTROLS

FUEL FILLING LEVEL

1. Fuel filler collar
2. Anti splash plate
3. Maximum fuel level

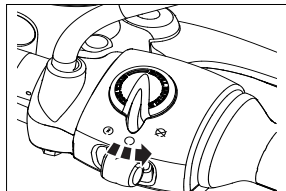
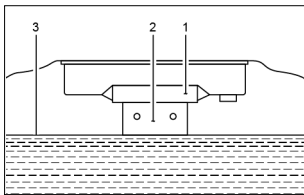

CAUTION

- In case of prolonged stoppage of vehicle, please turn off ignition key to avoid discharge of battery.

IGNITION/ENGINE KILL SWITCH



"OFF"



"ON"

E-START SWITCH



Push and hold electric start switch until engine starts for a maximum of 5 seconds.

OPERATION OF CONTROLS

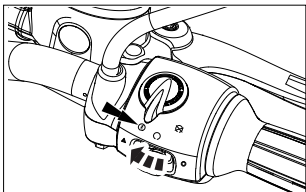

HAZARD LIGHT SWITCH

▲ "ON"

● "OFF"

WARNING

- Turn signals do not work when the hazard light switch is "ON".
- All the trafficator lamps will flash simultaneously.

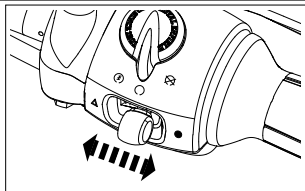

HORN

 Press the horn button to sound horn.

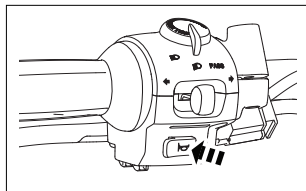

OPERATION OF CONTROLS

HIGHBEAM/LOWBEAMSWITCH

- When the headlamp is in "ON" condition High / Low beam will be selected by toggling the switch. High beam indicator tell tale located in instrument cluster will glow when high beam is selected.

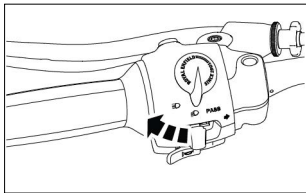

- High beam
- Low beam



WARNING

- Use appropriate high/low headlamp beam as per the traffic and road conditions for your safety and to avoid inconvenience to other riders.

FLASH SWITCH

- Push the switch for headlight flash.

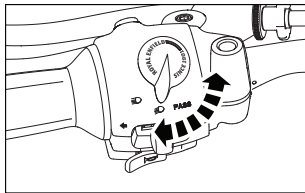

OPERATION OF CONTROLS

- Push the switch to operate high beam filament in head light. This provides indication to vehicle coming from opposite side while overtaking.

TURN SIGNAL SWITCH

- ← Left turn signal "ON"
- ↑ "OFF" (Push to cancel)
- Right turn signal "ON"

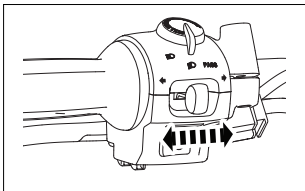

- Push the button from "OFF" position to either left or right before turning as needed. To cancel the turn signal lights, push the switch in after it has returned to the center position.

SIDE PANEL RIGHT

- Turn key clockwise to unlock the right side panel.
- Gently open the right side panel.

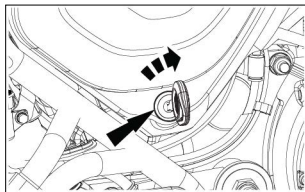

OPERATION OF CONTROLS

SIDE PANEL LEFT

- To access the left side panel loosen and remove the 2 nos of Allen bolt by using 5 mm Allen key.
- Slide the cover to the LH side, and pull it out wards.

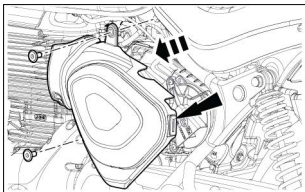

SEAT DISMANTLING

- Remove the right side panel as per recommended procedure.

- Pull the seat release cable to release seat lock.

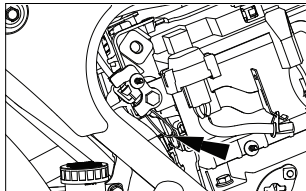

- Lift the seat from rear end and slide it towards tail lamp to remove seat.

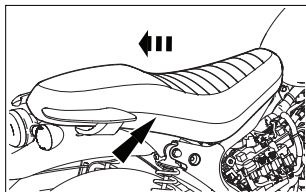

OPERATION OF CONTROLS

NOTE

- Place the removed seat in a safe location to prevent from scratches and dirt.

SEAT ASSEMBLY

- Ensure the seat latch retaining bracket is assembled properly.

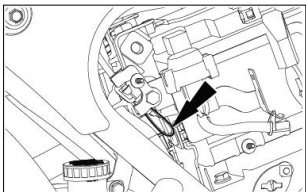

- Place the seat on rear end and slide it towards fuel tank to fix seat.

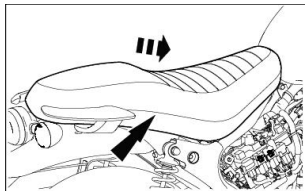

- Locate the right side panel into the frame. Insert ignition key and turn anti clockwise to lock and fix the right side panel on the motorcycle.

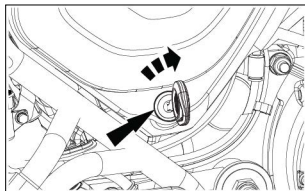

OPERATION OF CONTROLS

INSTRUMENT CLUSTER

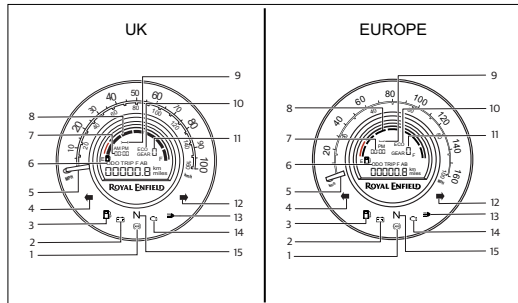

1. ABS Indicator
2. Battery low voltage indicator
3. Low fuel indicator
4. Left turn indicator
5. Speedometer indicator
6. ODO meter / Trip meter (A/B/F)
7. Clock
8. Fuel gauge
9. Service reminder
10. ECO mode
11. Gear indicator
12. Right turn indicator
13. High beam indicator
14. Engine malfunction indicator
15. Neutral indicator

DISCLAIMER

- Cluster unit display may look dull during sun overhead conditions. This is normal and due to impact of direct sunlight on the unit customers to refer during other riding conditions.

OPERATION OF CONTROLS

SERVICE REMINDER

- If service reminder symbol is ON, please arrange a scheduled service at an authorised service center.

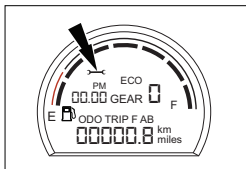

- Service reminder can be reset only by authorised personnel at service centre after service is completed.
- Service reminder symbol will flash on as per below distance input from odometer.
 - 1st service - 450 km or 279.6 miles
 - 2nd service - 4,900 km or 3044.7 miles
 - From there on for every 5,000 km or 3106.8 miles from previous value (ex: 9,900 km or 6151.5 miles, 14,900 km or 9258.4 miles etc.)

ODOMETER

- Displays the cumulative kilometers the vehicle has covered.

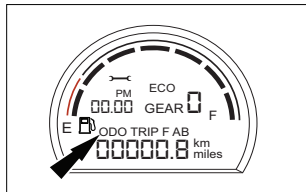

Unit Changeover

- Change the gear to neutral mode and turn the ignition switch OFF.
- Hold the info button and turn the ignition switch to ON.
- Long press the info button for 15 seconds approximately during ignition switch ON.

OPERATION OF CONTROLS

- ODO reading changes from miles to km and Vice versa.

CLOCK

- Display in 12 hour format with AM/PM indication.
- Will reset to 12.00 AM when battery is disconnected.

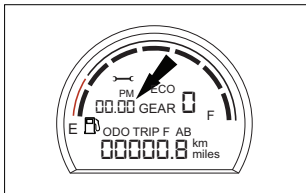

ECO MODE

- The ECO indicator on the instrument cluster will appear when the motorcycle is ridden at the optimum engine speed and gear ratio. It may also consider the road condition and payload.



TRIP A/B

- Trip A/B indicates distance traveled in particular trip.

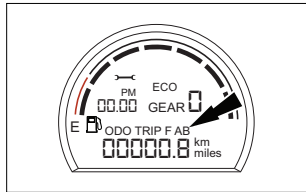

OPERATION OF CONTROLS



WARNING

- Never attempt to operate the info buttons while riding the motorcycle. Doing so will cause loss of concentration and unstable riding, leading to a potential accident, resulting in serious injury to both rider and other road users, besides causing severe damage to the motorcycle.

FUEL GAUGE

- Digital with 7 segment bar graph. Last segment blinking along with low fuel tell tale "ON" for low fuel condition.

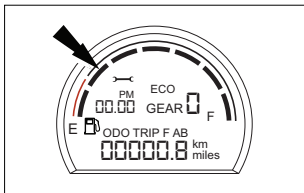

WARNING

- Do not use the motorcycle for long duration with the fuel indication in last segment blinking. Refuel at the earliest opportunity.
- Failure to do so will cause the motorcycle to run out of fuel and get stranded in addition to causing serious damage to the fuel pump.

GEAR POSITION INDICATION

- Displays the gear position in which the vehicle is traveling.

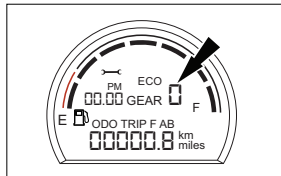

OPERATION OF CONTROLS

- When in neutral the indication will be "0".
 - When in gear the appropriate number between 1 to 5 will be displayed.
-

TELL TALES

- **(1) Turn left:** Left turn signal ON.

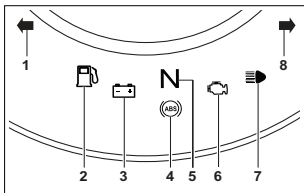

- **(2) Low fuel indication:** Last segment blinking along with low fuel tell tale ON for low fuel condition.
- **(3) Low battery indication:** Indicator will glow continuously if ignition switch is ON & engine is not running. Indication will switch off as soon as engine is

started. If battery voltage is below 12 V, indicator will glow continuously indicating a low battery.

- **(4) ABS MIL:** Will be continuously ON during initial check up (until or after vehicle running for a particular distance / speed) and will turn OFF if system is ok, then will light up again in case of any ABS system malfunction.
 - **(5) Neutral indicator:** Transmission is in neutral.
 - **(6) EMS malfunction indication:** will be continuously ON in case of EMS malfunction.
 - **(7) High beam indication:** Head lamp high beam ON.
 - **(8) Turn right:** Right turn signal ON.
-

CAUTION

- Do not run motorcycle incase the malfunction remains "ON" continuously as it can cause severe damage to the ECU & Sensors. Please visit the nearest authorised Royal Enfield dealer to diagnose & rectify the defect in the EMS.
- Do not run motorcycle incase the ABS indicator lamp continuously "ON".

OPERATION OF CONTROLS

NOTE

Tell tales lights will switch "OFF" after engine is started.

TRIP "F" MODE

- Distance driven after low fuel tell tale is "ON".

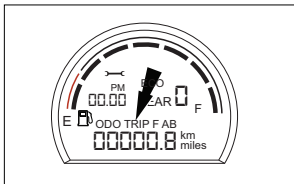

- Cannot be re-set. It will be visible only when low fuel condition is sensed, will vanish if fuel is filled above low fuel condition.
- Display can be toggled using info button during this condition but will auto appear after 25 seconds. This is linked with stand switch to avoid re-set when in side stand condition.

- If ridden > 200 km in Trip F condition "Low Fuel" will flash continuously on LCD. It is recommended not to ride vehicle in these condition as it will result in fuel pump damage.

TRIP "F" CONDITION

- Trip F will update only when kill switch is in ON condition.
- After fuel filling above reserve level, Trip F will continue to show for a few minutes, which is a normal behavior, this is to avoid wrong indication.
- Trip F reset will occur when riding in mid to rough road conditions due to frequent fuel oscillations. This feature is to be used for reference purpose only and on smooth road surfaces.
- If vehicle is parked in side stand fuel bars may ON due to fuel accumulated on one side. Trip F will be ON during side stand retracted condition after time delay.

NOTE

- Fuel Indication will vary on rough road, uphill and downhill conditions. For accurate indication refer during slow speed or flat surfaces.

OPERATION OF CONTROLS

Function	Switch	Pressure time (s)	Action
Clock setting mode	INFO	Press and hold INFO switch for 3 seconds and release	In ignition ON and with current display in ODO mode and no speed input (safety), press info button for specified time to enter into clock setting mode (hours will blink)
	INFO	Press and release INFO switch	Hours in the clock will increase
	INFO	Press and hold INFO switch for 3 seconds and release	Enter into minutes mode (minutes will blink)
	INFO	Press and release INFO switch	Minutes in the clock will increase
	INFO	Press and hold INFO switch for 3 seconds and release	Enter into unit mode (AM / PM will blink)
	INFO	Press and release INFO switch	Toggle between AM or PM
	INFO	Press and hold INFO switch for 3 seconds and release	Save data and exit clock setting mode

NOTE

If no action is observed in the clock setting function for more than 20 seconds, the last value shown will be displayed.

OPERATION OF CONTROLS

INFO BUTTON MANAGEMENT DETAILS

- LCD SEQUENCE (Info switch press <1 s):-If Trip F enabled.

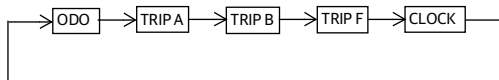
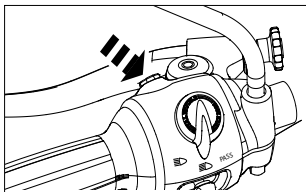

- If Trip F not enabled.

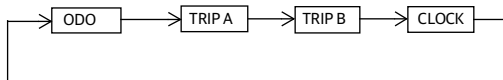
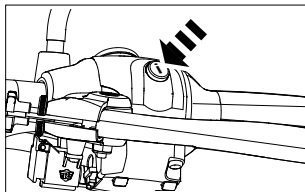

NOTE

- For trip re-set press info button for >3 s.

OPERATION OF CONTROLS

Function	Switch	Pressure time (s)	Action
ODO	INFO	Press and release INFO switch	Turning ignition key "ON" displays ODO km in cluster and enter into Trip A mode
TRIP A	INFO	Press and release INFO switch	Trip A display mode and enter into Trip B mode
	INFO	Press and hold INFO switch for 3 seconds and release	Reset Trip A km value
TRIP B	INFO	Press and release INFO switch	Trip B display mode and enter into ODO/Trip F (If enabled) mode
	INFO	Press and hold INFO switch for 3 seconds and release	Reset Trip B km value

NOTE

Trip A/Trip B- If it reaches 999.9 km and the odo reaches 99999.9 km, it will reset to zero again automatically without any notification.

OPERATION OF CONTROLS

ABS INDICATOR LAMP

- When the ignition and engine kill switch are switched in "ON" position the ABS sign will glow and remain "ON" till the motorcycle attains a speed of 5 kmph and turns "OFF". If light up again in case of any ABS system malfunction.

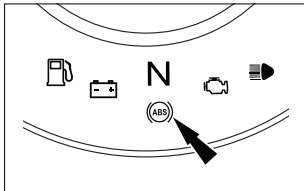

CAUTION

- Do not run the motorcycle incase of ABS indicator lamp is "ON" continuously above 5 kmph / 3.1 mph.

OPERATION OF CONTROLS (IF FITTED)

TRIPPER

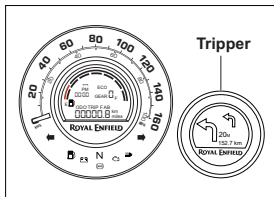

- Tripper is included to provide turn-by-turn navigation on the motorcycle, to help riders to have a hassle free ride without having to handle their smartphone. This device works based on Bluetooth connectivity with navigation search based on RE Mobile app with the support of Google Maps.
- Device is capable of showing turn by turn navigation on a custom designed round colour TFT with uniquely designed arrow font designed intuitively for ease of riding.

- Background display can be switched between day mode and night mode which can be selected by riders from RE Mobile app.
- Scan the QR Code, to download, install, register and to know more about the tripper.



OPERATION OF CONTROLS (IF FITTED)

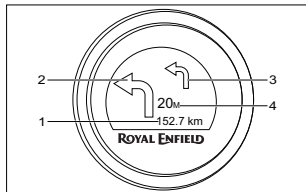

- 1.Distance to destination or ETA
- 2.Primary direction or next turn
- 3.Secondary direction or next to next turn
- 4.Distance to next turn

Features:

- Turn by turn navigation with primary turn, secondary turn.

- Distance to next turn, distance to destination or Estimated Time of Arrival (ETA).
- Clock display (in case of no connectivity, no navigation input or after destination is reached).
- User can select day and night mode (through RE Mobile app only).
- Mobile phone low battery indication.

DISCLAIMER:

- Tripper unit display may look dull during sun overhead conditions. This is normal and due to impact of direct sunlight on the unit. Customers should refer to it during other riding conditions.

OPERATION OF CONTROLS (IF FITTED)

- Primary direction or next turn: Indicates the next turn to be taken along with the distance.
- Distance to next turn: Shows the distance to next turn.
- Secondary direction or next to next turn: Indicates the next turn to be taken after the primary direction, will be shown only when primary turn is less than 100 m, if there is no turn the display will be blank in this region.
- Distance to destination or ETA: Shows the total distance to destination or Estimated Time of Arrival (based on user selection from RE Mobile app).

Compatible smartphone versions to use RE Mobile app:

- Compatible with Android and iOS.
- Android Support: Current version (-2).
- iOS support: Current version (-1).
- Connectivity control only through RE Mobile app.

OPERATION OF CONTROLS (IF FITTED)

NOTE

- After every Ignition "ON" cycle tripper will be in discoverable mode for 120 seconds.
- In case there is no connection established within 120 seconds, the will enter into clock mode. To re-initiate connection, repeat the ignition "OFF-ON" cycle.
- During navigation mode if there is no input from smart-phone for 5 seconds, Bluetooth connection will be terminated to avoid power draw and the tripper will display the clock.
- Bluetooth connection can be terminated by end user also by closing the mobile application.
- For first time pairing, user needs to enter the secured pin shown on tripper through RE Mobile app to setup the device. After that, auto-pairing will happen if same device is connected.

- Every time the tripper is paired the clock time will sync with mobile time, after which it will continue to run with internal clock even in case of disconnection. There will be time difference between time shown on instrument cluster and tripper - customer needs to update cluster clock in line with time shown on tripper as and when required, as per the section on the Clock setting mode for the cluster.
- Do not apply or use gasoline / petrol related fluids for cleaning or wiping the instrument cluster or tripper, as it may result in permanent damage to the same.

CAUTION

- Ensure ignition is ON and display is powered while establishing connection.
- Ensure first time pairing is done in isolated environment to avoid cross connections (one time).

OPERATION OF CONTROLS (IF FITTED)

- Day and night mode is user selectable only. It will not change over, and be selected automatically during night driving to avoid rider distraction.
- Bluetooth connection can be established only through RE Mobile app.
- Ensure Bluetooth and location settings are always turned "ON" before usage.
- Disable battery optimization settings / low battery cut-off setting of smartphone for navigation to work in low battery mode.
- RE Mobile app works only with Android (Current Version (-2)) and iOS (Current Version (-1)) versions, for other lower versions performance lag can be expected.
- Tripper Bluetooth version is 4.2.
- RE Mobile app works with Bluetooth version 4.2 and N+1.0, for other lower versions performance lag can be expected.
- Check for network signal strength in case of navigation lag.
- Check for data speed in case of navigation lag, navigation system performance is better in 4G band compared to other lower versions.
- Calibrate mobile phones frequently for more GPS accuracy & location accuracy.

OPERATION OF CONTROLS

CHARGER PORT

- Fast charging charger port is located on left side handle bar beneath the turn signal switch.

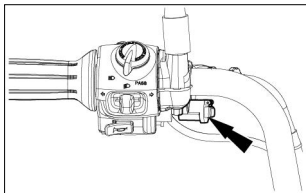

WARNING

- Recommended not to use in rainy conditions to avoid damages to smart phones and charger, RE shall not be liable for any damage to smart phones.

- Do not use any other device other than mobile phones, only one mobile shall be charged at one point of time.
- Ensure proper insertion of USB cable, damages due to hard / wrong insertion of cable will not be entertained in warranty.
- Do not leave the USB port cap partially opened / closed partially to avoid any short circuit when not in use.
- Do not insert any metal or conductive materials inside USB charging port which may lead to short circuit.

NOTE

- Charging port is provided only for charging purpose and no data transfer is enabled.
- Duration of charging can be higher and will vary for different make mobile phones depending on smart phone battery capacity, SOC and smartphone charging circuits.

OPERATION OF CONTROLS

CAUTION

- Customer to ensure USB port cap is closed and locked properly when not in use, warranty will not be provided if port cap is damaged and not sealed properly.
- Fast charger works based on Mobile Battery Management System (BMS).
- It adjust the output voltage & current based on the connected mobile device battery demand.
- BMS demand based on the factors like charging protocol, battery charge percentage & cell temperature.
- USB charger will function only when engine is in running condition.
- Use standard approved and high quality USB cables for proper functioning.

WARNING INDICATIONS AND SAFETY SYSTEMS

ANTI-LOCK BRAKING SYSTEM (ABS)

- Anti-lock braking system (ABS) will help prevent the brakes from locking the wheels, during sudden application of the brakes at high speeds or at low friction surfaces. This will help the rider to have better traction and control over the motorcycle and prevent the motorcycle from skidding which can cause an accident.

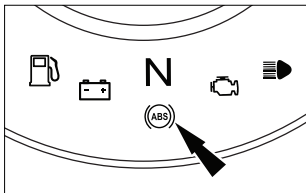

- In the event of a sudden and hard application of the brakes by the rider, the sensors in the braking system

will signal the ABS modulator to momentarily and continuously reduce the hydraulic pressure and thereby prevent the brakes from locking the wheels while reducing the speed of the vehicle. This will help the rider to control the motorcycle.

- An ABS indicator lamp is provided in the cluster (as shown in the adjacent image) to warn the rider in the event of any malfunction of the ABS.
- When the ignition and engine kill switch are switched in "ON" position the ABS sign will glow and remain "ON" till the motorcycle attains a speed of 5 km/h and turns "OFF". This indicates the ABS is functioning properly. If the ABS indicator lamp does not switch "OFF" and remains continuously "ON" at higher speeds, it is recommended not to drive the ABS motorcycle. Get the brake system inspected and corrected through a nearest Authorised Royal Enfield Service Centre. Failure to do so can result in a serious injuries and loss of life.

WARNING INDICATIONS AND SAFETY SYSTEMS

CAUTION (ABS)

- ABS is a safety feature to help prevent locking of wheels during panic application of brakes. It is by no means a substitute for good riding practices and anticipatory braking.
- Please ride carefully and apply brakes cautiously, especially while cornering. ABS cannot estimate the "weight shifts" and momentum of the motorcycle while negotiating a corner and therefore prevent skidding due to loss of traction.
- Please anticipate the stopping distance required for the speed of travel and apply brakes well in advance so as to bring the motorcycle to a safe stop.
- Ensure instrument cluster is in proper functioning as it is an integral part of ABS system.

- Please apply both brakes simultaneously to stop with better traction and control of the motorcycle.
- Failure to adhere to the above can cause an accident resulting in serious injuries and loss of life.



WARNING

- Always use the approved front / rear tyres and rear sprocket by Royal Enfield to ensure correct ABS operation.
- Do not make any changes to the suspension travel.
- Only use recommended spare parts on the brake system which have been approved by Royal Enfield.
- ABS does not reduce braking distance. In certain circumstances, ABS may result in a longer stopping distance.

WARNING INDICATIONS AND SAFETY SYSTEMS

CAUTION (ABS)

- Visually inspect for damaged teeth on the front and rear ABS toner rings.

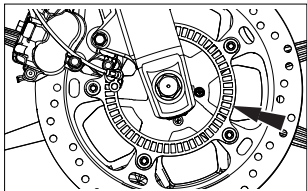

- Inspect for damages and dents on the face of the teeth.
- The teeth edges should be consistent in appearance. In case if a toner ring is found to be damaged or bent, it is recommended to visit nearest dealership for necessary action.

- Inspect for debris at the end of the wheel speed sensors - front & rear, if contamination is observed, it is recommended to clear it suitably or you may visit to nearest dealership for necessary action.

ROLL OVER SENSOR

In the event of motorcycle falling over in either of its sides with the engine running and the gears engaged the roll over sensor will "Disable" fuel systems and switch "OFF" the engine. This is to prevent any damage to the motorcycle and its rider. To reset the roll over sensor and reactivate the fuel systems.

- Ensure the motorcycle is made upright and is on its center stand.
- Ensure gears are in correct neutral and the neutral lamp is glowing in the instrument console.
- Switch "OFF" both ignition & stop switches, wait for a few seconds and switch "ON" the ignition and stop switch again, to start the engine.

WARNING INDICATIONS AND SAFETY SYSTEMS

DO'S AND DON'TS: (ABS)

DO'S	DONT'S
<ul style="list-style-type: none">■ While starting the engine do check the ABS indicator glows "ON" and turns "OFF" when the vehicle speed exceeds 5 kmph.■ Please check the brake fluid at "MAX" level in the front and rear brake reservoir and ensure there is no leak in the brake systems.■ Apply both the brakes simultaneously for better efficiency.■ In the event of the ABS indicator remaining continuously "ON", please take the motorcycle to a nearest Authorised Royal Enfield Service Centre to inspect the brake system.	<ul style="list-style-type: none">■ Do not release the brake lever / pedal when pulsations are felt during hard application of the brakes in an emergency situation. The pulsations only indicate that the ABS is activated.■ Do not apply only the front or rear brake as it can lead to inefficient braking.

PRE-OPERATIONAL CHECKS

A careful check of the following must be carried out every time before riding and especially after long periods of storage to determine if any additional maintenance is necessary.

1. Adequate fuel in the tank for the journey planned.
2. Tyre for correct pressure, abrasions or cuts.
3. Rear chain for proper tension and sufficient lubrication.
4. Brakes, clutch, steering and throttle for proper responsiveness.
5. Smooth operation and free play in front and rear brake levers.
6. Engine oil level.
7. Headlamp, tail lamp, brake lamp and indicator lamps for proper functioning.
8. Proper functioning of all the warning lamps in the instrument cluster.

9. Brake fluid level is above the "MIN" mark in the master cylinder.
10. Ensure the clutch free play and clutch function.



WARNING

For your personal welfare and safety, all the points mentioned above should be performed periodically. Failure to do so may affect safe operation, damage your motorcycle and could result in an accident causing serious injury.

RUNNING IN PERIOD

The Royal Enfield motorcycle as you would be experiencing is capable of consistent high speeds. However as with any new motorcycle, a "Running-in" procedure is essential to help in proper "Bedding-in" of the various moving parts in your motorcycle and to achieve optimum performance like gear shifting subsequently.

1. Do not exceed maximum specified pay load. Tyres for correct pressure, abrasions or cuts.
2. Warm up the engine for a few minutes at idling speed to allow engine oil to lubricate all the moving parts in the engine before riding the motorcycle. Brakes, steering and throttle for proper responsiveness.
3. Avoid full throttle operation and do not ride at constant throttle continuously. Vary the speed by 10% while riding.
4. Ride at proper speed and avoid sudden accelerations and braking.

5. Avoid riding motorcycle continuously for over an hour, it is recommended to take brief stop.

NOTE

During the running-in period, do not exceed the following speed limits.

Gear	Motorcycle speed			
	First 500 km (0 to 311 miles)		501 - 2000 km (311 to 1242 miles)	
	kmph	mph	kmph	mph
1	20	12	25	16
2	30	19	35	22
3	45	28	50	31
4	60	37	65	40
5	70	43	80	50

STARTING

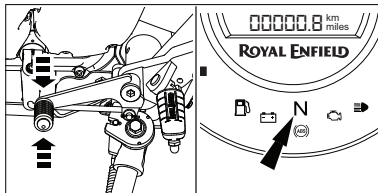

- To shift into neutral, move the motorcycle back and forth gently, while simultaneously shifting the gear. Ensure gear is in neutral position and the neutral lamp is glowing in the instrument cluster.
- Turn ignition key to ON position and engine kill switch on right hand side handle bar to run position.
- When both the ignition and engine kill switch is in "ON" position and after the vehicle is started, the MIL will glow for a few seconds and turns "OFF", this indicates that all the function of the electronic fuel injection (EFI) system is functioning normally. In the event

of any malfunction in the EFI system the MIL will glow continuously.

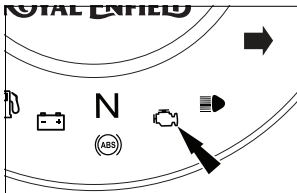
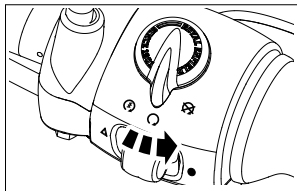

STARTING

CAUTION

- Once the kill switch is ON, then only N (neutral) tell tale will glow in instrument cluster.
- In case the malfunction indicator does not turn OFF, get the motorcycle checked through an Royal Enfield Authorised Service Centre for rectification.
- Check the fuel level indicator in the cluster for adequate fuel in the fuel tank. In case the last bar is blinking continuously, it indicates low fuel level in the tank. Please re-fuel immediately.
- Disengage clutch by pulling in the clutch lever and hold it in depressed condition.

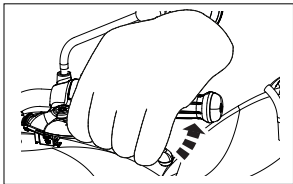

- Push and hold electric start switch until engine starts for a maximum of 5 seconds.

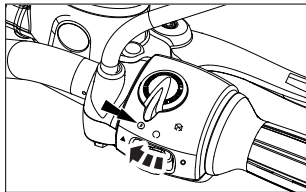

NOTE

- In case the engine does not start within 5 seconds, release starter switch and wait for about 5 seconds before attempting to start the engine again.
- In case vehicle not starting on multiple continuous attempts, please turn OFF and turn ON ignition switch and then start again.

STARTING

PRECAUTIONS

- Vehicle may start with side stand condition but will turn-off when gear is engaged, this side stand cut-off feature is provided for rider safety ensure side stand is removed before vehicle moving / starting.

CAUTION

- If the engine does not start. Do not hold the starter switch in depressed condition for long periods, this will cause the battery to drain below the threshold level of 10 V. Please get the motorcycle checked through an Royal Enfield Authorised Service Centre to identify and correct the reason for not starting.
- Never accelerate as soon as the engine starts, especially in cold condition. The engine should be allowed to run in idle rpm for at least 120 seconds for the engine oil to circulate and lubricate all the internal moving parts and for the engine temperature to raise.

Failure to adhere to this important information will cause serious damage to the engine internals.

- Accelerate only after the idling rpm has stabilized and it is consistent.
- Ensure side stand is in fully retracted position. Failure to do so will cause the engine to switch "OFF" as soon as gear is engaged.



WARNING

Please exercise extreme care while riding the motorcycle. Failure to do so can result in an accident causing injury to you or to other road users / passerby.

- Ensure gear in neutral position and the neutral lamp is glowing in the speedometer. To shift into neutral, move the motorcycle back and forth gently, while simultaneously shifting the gear.

STARTING

CAUTION

Do not attempt to shift gears without moving the motorcycle back and forth as it will damage the gears mechanism.

- Depress and hold the clutch lever.
- Press starter button and hold till engine starts. Do not release the button before engine starts.

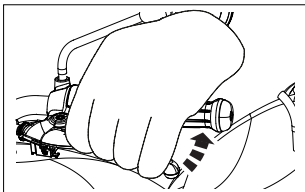

- Do not press the starter button for more than 5 seconds after cranking it three times in a row; wait for 15 to 20 seconds for the battery to recover.

GEAR SHIFTING, RIDING AND STOPPING

The clutch lever must be fully depressed before attempting a gear shift. Failure to fully depress the clutch lever will cause a rough start or stalling of the engine besides causing damage to transmission parts.

- When the vehicle is in Neutral position, press gear shift lever down with toe to engage 1st gear.

GEAR SHIFT PATTERN

1 -- N -- 2 -- 3 -- 4 -- 5

Half clutch usage pattern:

To maintain smooth control at low speed (<10 km/h), it is recommended to partially engage ('slip') the clutch while applying the throttle in order to prevent the engine from stalling. When holding the clutch in this partially engaged position, the motorcycle should be in 1st gear and at low engine RPM, in order to avoid excess wear or damage to the clutch components.

- Holding the clutch in a partially engaged position at lower speeds in 2nd gear or above will require higher engine RPM in order to prevent stalling as the clutch is released. This will increase clutch 'slip' and is likely to result in premature wear of clutch components.
- After shifting from one gear to another engage the clutch gradually (Not slowly).
- Wherever possible use the vehicle in clutch fully disengaged condition only with appropriate gears, which will give good clutch life.

GEAR SHIFTING, RIDING AND STOPPING

Recommended up shift speeds

Gear change	Km/h	(mph)
1 st - 2 nd	20	12.4
2 nd - 3 rd	30	18.6
3 rd - 4 th	40	24.8
4 th - 5 th	55	34.2

Recommended downshift speeds

Gear change	Km/h	(mph)
5 th - 4 th	50	31.1
4 th - 3 rd	35	21.7
3 rd - 2 nd	25	15.5
2 nd - 1 st	15	9.3

CAUTION

- If the clutch lever is released abruptly and throttle opening is done insufficiently the motorcycle will have a rough start and cause the engine to stall.

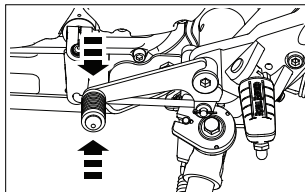

- If the acceleration is very high and clutch lever is released abruptly, it will cause motorcycle to move suddenly, which will lead to loss of control leading to an accident resulting in injury and or loss of life to rider/ other road users / passed by, besides damage to the motorcycle.

GEAR SHIFTING, RIDING AND STOPPING

- Always exercise utmost caution while releasing clutch and riding the motorcycle.
- Follow the recommended upshifting and downshifting speeds.

NOTE

- Always start motorcycle with the gear in neutral condition.
- Always move the motorcycle in first gear position only.
- When the engine speed decreases or while climbing a gradient or running at a reduced speed, shift to the appropriate lower gear to prevent the engine from stalling or straining to pull.
- The clutch lever must be fully depressed, throttle modulated and immediately shifted to next gear as per recommended gear shifting speeds.
- Failure to follow the above may cause a rough start or stalling or improper gear shifting of the engine besides causing damage to transmission parts.
- Always shift gears to neutral position just before bringing the vehicle to a complete stop.
- Close throttle fully and release the clutch lever slowly ensuring the motorcycle is in neutral position and neutral lamp is glowing.
- Stop the motorcycle in a safe place, turn OFF ignition and switch OFF engine kill switch.
- While riding on steep slopes and descending long roads it is recommended to use the brake intermittently along with engine braking in a combined way to achieve effective braking. Engine braking is achieved by performing downshifting of the gear from the current gear to slow down the vehicle.

PARKING

PARKING MOTOR CYCLE ON CENTER STAND

- Park the motorcycle in an upright position.
- Hold handle bar firmly in a straight position.
- Lower center stand, such that, both the legs of the stand are resting on firm ground.

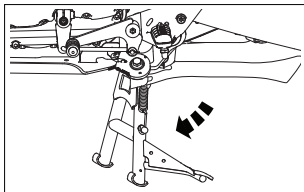

- Apply pressure on the fulcrum lever on the center stand and pull motorcycle backward.

- Lock the steering and ensure the handle bar is locked firmly before removing the key from the ignition barrel.

PARKING MOTORCYCLE ON SIDE STAND

- Park the motorcycle in an upright position.
- Extend side stand. Tilt the motorcycle to the left side, till it is supported firmly on the ground.

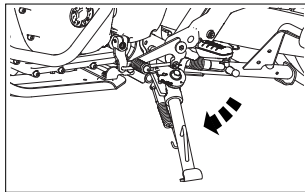

PARKING



WARNING

- Ensure both stands are fully retracted before riding the motorcycle.
- Please exercise extreme care while parking and ensure it is parked on a firm and flat surface to avoid the motorcycle falling over and causing injury to yourself or to others and damage to the motorcycle parts.
- The side stand is only designed for the weight of the motorcycle. Do not sit on the motorcycle when it is resting on the side stand. The side stand or frame may become damaged and the motorcycle may fall over.

TOOL KIT

The tool kit is located in the underneath on the seat of the motorcycle.

S.No	Description	Qty
1	Allen key 6 mm	1
2	Fuse puller	1
3	Spark plug tool (8x16 Box Spanner)	1
4	Ring spanner 24x14-24 (Eye wrench) x 14 (Open end) combination	1
5	Open end spanner 17 x13	1
6	D/E Spanner 10 x 12	1
7	Screwdriver 06 x 120/135	1
8	C-spanner	1
9	Extension tube 28x7 & 24 x 14	1

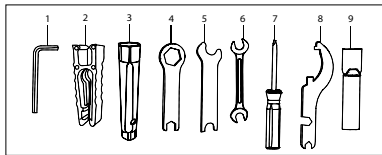

MINOR MAINTENANCE TIPS

The following simple maintenance activities will help in maintaining your motorcycle. However for an elaborate maintenance, we recommend you to get in touch with a Royal Enfield Authorised Dealer / Service centre.

CONTROL CABLES

Lubricate after water washing motorcycle or if used during rainy conditions.

HAND LEVERS, CENTER AND SIDE STAND PIVOTS

- Clean the pivot points and ensure they are free of any dirt, grime, rust, etc.
 - Lubricate the pivots.
-

NOTE

Wipe off the excess lubricant to prevent dirt and grime from accumulating.

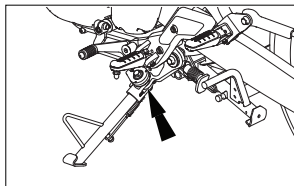

DRIVE CHAIN

- Spray drive chain with recommended chain cleaning solvent while simultaneously rotating rear wheel.

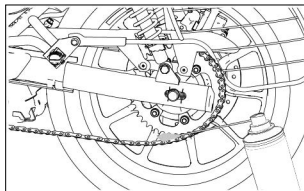

MINOR MAINTENANCE TIPS

- Ensure the drive chain has been sufficiently and completely covered with the cleaning solvent. If necessary use a suitable brush to remove hard deposits from the chain.
- Wait for a few minutes and clean the chain thoroughly to remove any dirt, grime, etc.
- Rotate rear wheel slowly and simultaneously apply recommended chain lubricant on the chain links.
- Wipe off excess chain lubricant after a few minutes with a clean cloth.

ENGINE OIL LEVEL CHECKING

- Ensure the vehicle is in center stand.
- Switch on the engine and gently raise the RPM (Half throttle) for 10 seconds.
- Leave the vehicle in idling condition for 15 seconds.
- Switch OFF the engine & wait for the oil to settle down (Approx 1 to 2 minutes).
- Engine oil level should be at max level.

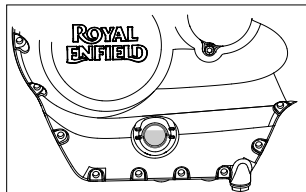

- If oil level is not in above mentioned condition, then top-up the oil to "MAX" mark and repeat the procedure.
- Do not over fill above the "MAX" mark as it may affect the clutch function.
- Switch OFF the engine & wait for the oil to settle down (Approx 60 - 120 s).
- Engine oil level should be max level.

MINOR MAINTENANCE TIPS

ENGINE OIL DRAINING

- Ensure vehicle is in straight position on ground level.
- Engine oil should always be drained when the engine is warmed up sufficiently so that the oil drains faster.
- Place a tray under engine oil drain plug and remove bolt along with cap and O-ring.
- Wait for 5 minutes minimum till the engine oil drains completely.

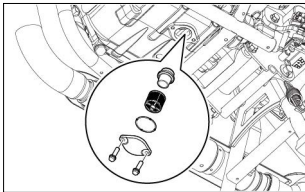

OIL FILLING DURING OIL SERVICE

- Ensure vehicle is in straight position on ground level.
- Clean the oil filter joint face in crankcase and new oil filter to be assembled along with new rubber gasket.
- Clean the oil drain hole joint face in oil pan and drain bolt.
- New washer to be used. Assemble the drain bolt with the specified loctite.

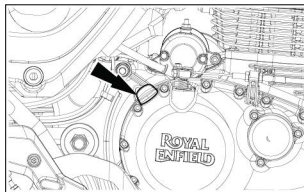

- Remove the oil filler plug & clean the oil filler cap joint face in crankcase and filler plug.

MINOR MAINTENANCE TIPS

- Refill the specified fresh engine oil quantity to 1.7 L approximately.
- New oil filler plug O-ring to be used and assemble the oil filler plug into the crankcase.

SPARK PLUG CLEANING AND ADJUSTING PLUG CAP

- Disconnect spark plug caps from the spark plugs.
- Locate spark plug spanner on the spark plug, loosen spark plug and remove it from cylinder head.
- Check spark plug for carbon deposits and center electrodes for uneven wear.
- Clean the insulator tip and electrodes of the plug carefully.
- Check and set electrode gap between 0.7 to 0.8 mm.
- Always replace spark plugs only as per recommended specification.
- Refit the spark plug on the cylinder head as per tightening torque specification & refit the spark plug cap on the spark plug.

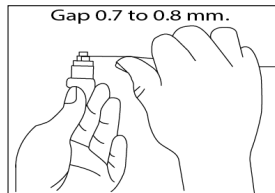

CHECKING BRAKE FLUID

Front: Check that the brake fluid reservoir is horizontal and that the fluid level is center of the window- consider the "MIN" level mark as a minimum level.

Rear: Check that the brake fluid reservoir is horizontal and that the fluid level is between the "MAX" level and "MIN" level marks.

MINOR MAINTENANCE TIPS

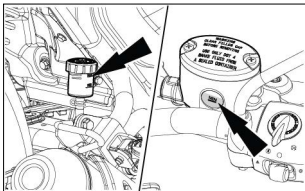

Place your motorcycle in an upright position on a firm, level surface.

CAUTION

- Brake fluid is highly corrosive and can cause damage to painted parts. Please ensure that brake fluid does not spill on any part of the motorcycle. In the event of a spill, please clean the area immediately with a soft cloth (preferably a wet cloth) to avoid damage.

- Do not mix DOT 4 & other brake fluid together.

NOTE

- Clean the filler cap before removing. Use only DOT 4 brake fluid from sealed container.
- Use only the specified brake fluid; otherwise, the rubber seals may deteriorate, causing leakage.
- Refill with the same type of brake fluid. Adding a brake fluid other than DOT 4 may result in a harmful chemical reaction.

Be careful that water or dust does not enter the brake fluid reservoir when refilling. Water will significantly lower the boiling point of the fluid and may result in vapor lock and dirt may clog the ABS hydraulic unit valves.

MINOR MAINTENANCE TIPS



WARNING

- An insufficient brake fluid level will cause the brake system to fail.
- Old brake fluid reduces the braking effect.
- Make sure that brake fluid for the front and rear brakes is changed in accordance with the periodic maintenance schedule.
- Keep brake fluid out of the reach of children.
- Do not allow brake fluid to come into contact with the skin, the eyes or clothing.
- Brake fluid is highly corrosive and can cause damage to painted parts. Ensure brake fluid does not spill on any part of the motorcycle. In the event of spill, please clean the area immediately with a soft cloth to avoid damage.

INSPECTION OF TYRES AND WHEELS

- Inspect the tyres periodically for tread wear, cracks and cuts.
- Check and remove stone, splinters, nails or other particles embedded in the tyre treads.

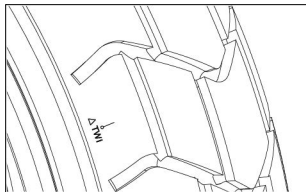

MINOR MAINTENANCE TIPS

- Periodically inspect wheels for spokes breakage and wheel rim run out.
- Check proper seating of the tyre beading on the rim whenever the tyre is reassembled.
- Use only recommended tyres, inflated to correct air pressure.

Tyre pressure	Front	Rear
Solo	29 psi	32 psi
With Pillion	29 psi	36 psi



WARNING

- It is recommended to operate the motorcycle with correct tyre pressure as under inflated tyres may cause tyre to overheat and may result in tyre damage and may cause injury to the rider.

- It is recommended to use Royal Enfield tyre specification in case of replacement of new tyres; failure to adhere to the specification may result in tyre damage and may cause injury to the rider.

BRAKE PADS

- The front and rear brake pads must be checked for wear at the intervals specified in the periodic maintenance chart.

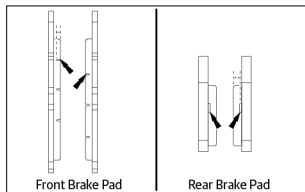

MINOR MAINTENANCE TIPS

Front/Rear : The pads need to be replaced if a brake pad is worn to the indicator.

NOTE

- Royal Enfield Motorcycles fitted with disc brakes have the optimum braking systems and are built to give a superior and safer braking performance under all conditions.
- Disc braking systems can produce a mild noise under certain riding conditions. This is absolutely normal and characteristic of the disc brake pads across the motorcycle industry. This in no way will affect the performance of the motorcycle or the braking system.
- At Royal Enfield, we have robust and rigorous testing and development protocols and adhere to global validation standards of quality and durability. We are committed to giving our customers the best possible ownership experience with our motorcycles.

FRONT WHEEL REMOVAL

- Ensure motorcycle is upright on a firm and flat surface.
- Place a scissor jack under the engine and lift motorcycle such that the front wheel is off the ground by minimum 15 cm.

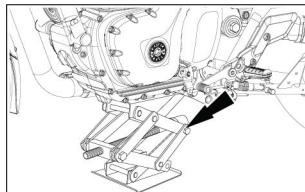

- Loosen and remove the Allen head bolt from front fork assembly on LH side by using 6 mm Allen key available in the tool kit.

MINOR MAINTENANCE TIPS

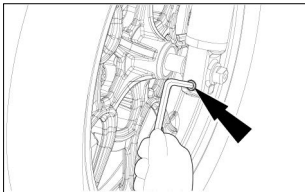

- Hold the spindle on the left side with 17 mm open end spanner and loosen and remove the pinch bolt on the right side fork end by using 24 mm ring spanner available in the tool kit.
- Remove the axle nut and washer.

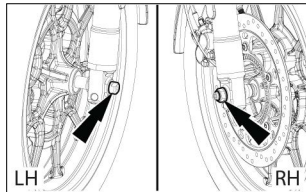

- Tap the axle out gently from the right side and remove completely from the left side.

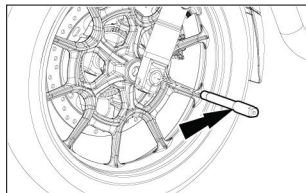

MINOR MAINTENANCE TIPS

- Slide out the wheel from the fork legs along with the speedo drive and spacer on the right side.

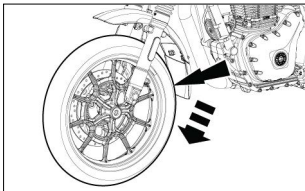

- Remove the speedo drive, small spacer on the right side and stepped spacer on the right side of the wheel hub.

CAUTION

Take care to secure the wheel spacers and speed sensor while removing the axle from the forks.

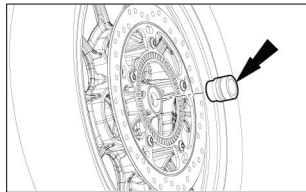

CAUTION

Do not press the brake lever when front wheel is removed as this will result in the brake pads coming too far out of the brake caliper.

- Place a 4 mm thick wooden piece or cardboard sheet between the brake pads to avoid pads activation in the event the front brake lever is accidentally pressed.

MINOR MAINTENANCE TIPS

- Take care not to damage the front brake disc or toner ring as it will affect the braking system and ABS.

FRONT WHEEL ASSEMBLY

- Remove the wooden piece / cardboard sheet placed between the brake pads.
- Locate small spacer and speedo drive over the wheel hub on the right side.
- Locate stepped spacer in the right side of the hub with its larger face on the outside.

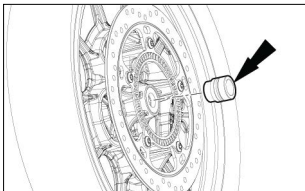

- Locate front wheel between the fork ends duly ensuring the spacer and the speedo drive do not fall off and the brake disc is correctly positioned between the brake pads.
- Ensure the peg in the speedo drive is correctly positioned in the slot in the right side fork end.
- Insert axle through the right side fork end and gently tap it in fully.

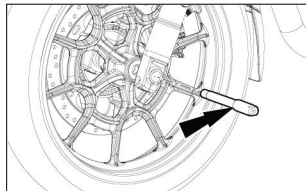

- Hold the axle from the left side and tighten nut on right side to 63-77 Nm.

MINOR MAINTENANCE TIPS

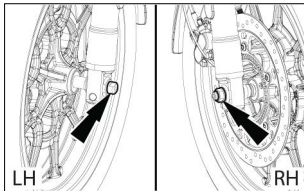

- Tighten fork clamp bolt firmly on LH side to a torque of 21 - 29 Nm.
- Rotate the wheel and check for smooth rotation.
- Connect the speedo cable to speedo drive and check for proper working of speedo meter.
- Depress brake lever 2 or 3 times to check front brake efficiency.

CAUTION

- Please exercise utmost caution while reassembling the front wheel on the motorcycle.

- Please ensure the wheel is fitted correctly before attempting to ride the motorcycle.
- Failure to do so may result in the motorcycle not performing correctly, may lead to an accident causing injury to you / other road users and may lead to loss of life.

REAR WHEEL REMOVAL

- Ensure motorcycle is upright on a firm and flat surface.
- Apply the center stand.

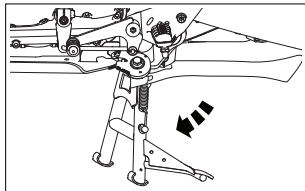

MINOR MAINTENANCE TIPS

- Observe and mark the alignment indexes on both chain adjusters on left and right side swing arm.
- Hold the spindle on the left side and loosen the nut on the right side by using 24 mm ring spanner available in the tool kit.

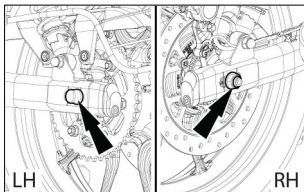

- Remove the axle nut and washer.
- Loosen Allen bolt on both LH and RH chain adjusters by using 6 mm Allen key available in the tool kit.

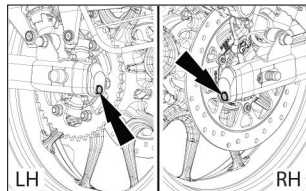

- Remove spindle from the left side of the rear wheel along with washer.

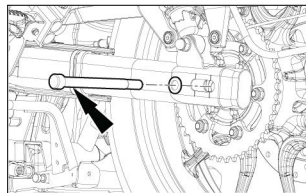

MINOR MAINTENANCE TIPS

CAUTION

Do not perform any operation on exhaust pipes and silencers soon after the motorcycle is OFF. They can get extremely hot and will cause serious injuries. Always wait until the silencer is completely cooled down.

- Gently remove chain adjuster assembly from swing arm LH and RH.

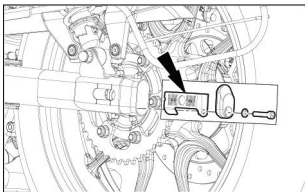

- Gently remove LH and RH spacer from the rear wheel hub.

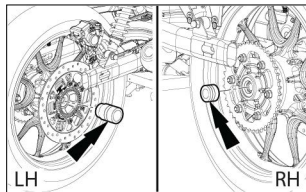

- Gently remove rear wheel from swing arm.

CAUTION

- Ensure brake hose does not get damaged or kinked while removing. Support caliper assembly suitably and away from swing arm.

MINOR MAINTENANCE TIPS

- Do not press the rear brake pedal when the rear wheel is being removed as this will cause the brake pads to dislocate from the brake caliper.
- Place a 4 mm thick wooden piece or cardboard sheet between the brake pads to avoid activation of brake pads if rear brake pedal is accidentally pressed.
- Do not pull up the rear brake pedal to lift or raise the motorcycle for any reason.

REAR WHEEL ASSEMBLY

- Gently locate rear wheel into swing arm. Insert spacer into rear wheel hub RH and LH.

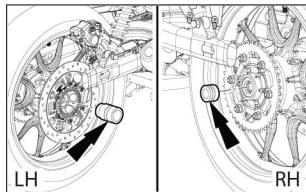

- Locate drive chain onto sprocket and align wheel into swing arm. Assemble chain adjuster assembly into swing arm LH and RH.

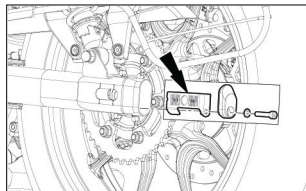

MINOR MAINTENANCE TIPS

- Insert spindle with tommy bar into rear wheel hub LH along with washer.

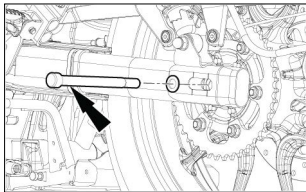

- Install washer into spindle RH and hold the spindle on the left side. Tighten the nut into swing arm on the right side to a torque of 63-77 Nm.

NOTE

- Do not tighten hex nut fully.

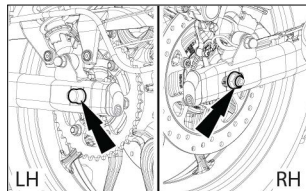

- Tighten the Allen bolt on both LH and RH chain adjusters.

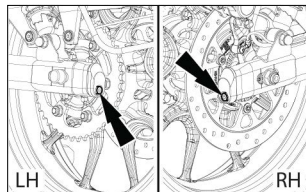

MINOR MAINTENANCE TIPS

- Check and ensure correct chain tension and wheel alignment.

CAUTION

Please exercise utmost caution while reassembling the rear wheel on the motorcycle.

Please ensure the wheel is fitted correctly before attempting to ride the motorcycle.

Failure to do so will result in poor performance of motorcycle which may lead to an accident causing injury to you / other road users and may lead to loss of life.

CLUTCH CABLE FREE PLAY INSPECTION/ ADJUSTMENT

- Clutch cable free play plays a major role in clutch life & it is recommended to adjust whenever required for good clutch life.

CLUTCH LEVER FREE PLAY SPECIFICATION

- Free play should be measured at ball end of clutch lever and should be 10 -12 mm when handlebars are at LH position (Refer the image).
- For adjustment follow below procedure:

NOTE

Clutch lever to be used 3 times before any measurement.

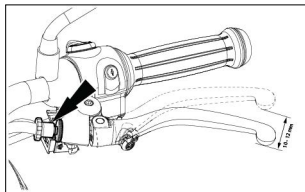

MINOR MAINTENANCE TIPS

CLUTCH CABLE ADJUSTMENT

- Loosen the cover end adjuster nuts at cover end completely.
- Tighten the adjuster at lever end on clutch perch fully in.
- Unwind hand adjuster 4 full turns.
- Adjust free play at engine to give zero free play. Tighten clutch cable adjuster nuts at cover end.
- To avoid parallax error, align the scale with starting point of ball during measurement.
- Set steering to the left lock position. Pull lever and release 3 times, adjust hand adjuster on clutch lever to give a 10 mm to 12 mm free play at ball end. Tighten the lock nut with full hand tight.
- Pull lever and release 3 times. Check free play is still within 10 mm to 12 mm. Adjust if necessary.
- Set steering to the straight position then pull lever and release 3 times. Ensure the free play is between 10 mm to 16 mm.

- Ensure that arm clutch release has positive free play (more than 0 mm) in left steering position by hand feel.

CAUTION

- If you are not comfortable to adjust free play as per stated procedure, please visit nearest service centre.
- If desired free play is not achieved or there is a suspected clutch slip, keep positive free play & visit nearest service centre.

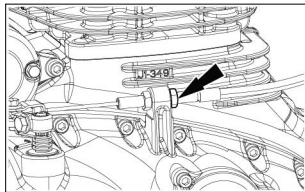

MINOR MAINTENANCE TIPS

- Adjuster nut should rest properly in the threaded region, with no overhanging (Ref. image)
- Clutch free play should be checked and adjusted only when the engine is cold.
- During clutch play checking, check the clutch cable for any abnormalities.
- If any abnormality suspected, visit nearest service centre.

DRIVE CHAIN TENSION (FREE PLAY 25-30 mm)

- Park motorcycle up right on a firm and flat surface.
- Ensure the motorcycle is in neutral position.
- Measure the drive chain free play as shown. The drive chain free play is 25 to 30 mm.
- If the drive chain free play is found to be incorrect adjust as follows:

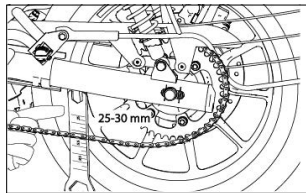

- (a) Loosen the axle nut of the rear wheel axle.
- (b) Tighten the LH & RH chain adjusters in the swing arm using a 6 mm Allen key available in the tool kit.
- (c) To reduce the free play, tighten the adjuster bolt on the adjuster evenly.
- (d) To increase the free play, loosen the adjuster bolt evenly and push the rear wheel forward.
- (e) Check the chain for correct chain tension.

MINOR MAINTENANCE TIPS

- (f) Ensure that the index marks on the adjuster and swing arm are same on both left and right side of the swing arm.
- (g) Hold spindle firmly to the left side and tighten rear hex nut.
- (h) Tighten the LH and RH chain adjusters in the swing arm using 6 mm Allen key available in the tool kit.



WARNING

Chain slackness beyond 30 mm will lead to chain slippage and may also cause increased wear rates to chain and sprockets.

Please ensure the both wheels are aligned correctly after adjusting the chain and before tightening the rear wheel spindle nut.

BATTERY AND MAINTENANCE

- The battery must be periodically checked for cleanliness and corrosion free terminals.

NOTE

The poor contact or loose fitment of battery terminals may cause electrical / electronic parts failure.

DISMANTLING

- Switch "OFF" the engine and remove ignition key from the key barrel.
- The battery is located on the right side of the motorcycle near the electrical fuse box.
- Insert the key into the right side panel, turn clockwise and open the right side panel cover.

MINOR MAINTENANCE TIPS

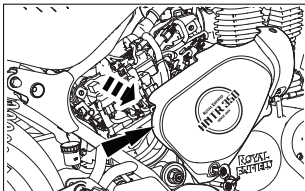

- Pull seat lock to remove seat from motorcycle. Remove the left side panel as per procedure.
- Remove battery support bracket along with fuse box and wiring.
- Disconnect battery negative (-ve) terminal bolt first and then remove the positive terminal (+ve) by using 10 mm spanner.

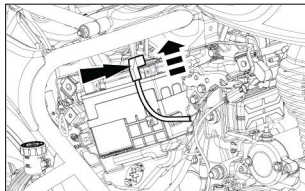

WARNING

1. Always disconnect the black negative (-ve) battery cable first.
2. Then the red positive (+ve) cable while removing the battery connections.

MINOR MAINTENANCE TIPS

- Gently remove battery along with tray from panel.

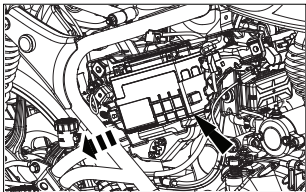

NOTE

Frequent usage of motorcycle is very important for battery to be in good performance condition. If the motorcycle is being used very rarely or sparingly and the terminals are not disconnected, the battery is bound to lose its charge and result in a dead battery.

For checking the battery voltage, contact Royal Enfield Authorised Service Centre or battery service centre.

ASSEMBLY

- Locate the battery in the carrier.

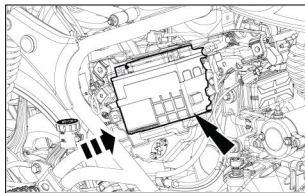

- Connect the +ve terminal first and then -ve terminal to the respective cables and smear petroleum jelly on the terminals and cover the terminals with the rubber sleeve provided on the respective cables.

MINOR MAINTENANCE TIPS

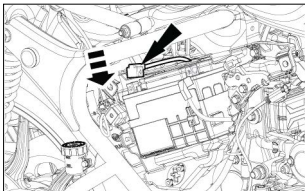

CAUTION

1. Always connect the red positive (+ve) battery cable first.
 2. Then the black negative (-ve) cable while refit the battery connections.
- Assemble the battery support bracket along with fuse box and wiring.

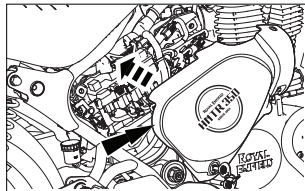

- Assemble the seat and close the right side panel cover and turn the key anticlockwise to lock the panel.

NOTE

Clean the wire terminals free from corrosion and keep the terminals coated with petroleum jelly.

CAUTION

Keep the red (+ve) positive terminal and (-ve) negative terminal cables firmly connected to the respective battery terminals. Failure to do so may result in damage to the motorcycle electrical system.

MINOR MAINTENANCE TIPS

CHANGING ELECTRICAL COMPONENTS

HEADLAMP

- The headlamp has a LED lighting system. In the event of failure, the headlamp LED assembly should be replaced.

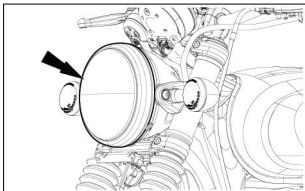

- Contact an Royal Enfield Authorised Dealer/Service Centre for a replacement.

TAIL LAMP & LICENSE PLATE ILLUMINATOR

- The tail lamp (A) & license plate illuminator (B) has a LED lighting system. In the event of failure, the entire tail lamp (A) & license plate illuminator (B) assembly should be replaced.

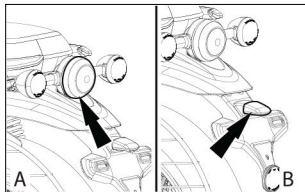

- Contact an Royal Enfield Authorised Dealer/Service Centre for a replacement.

MINOR MAINTENANCE TIPS

TRAFFICATOR BULB REMOVAL

- Loosen and remove screw along with washer from front trafficator lens by using screw driver.

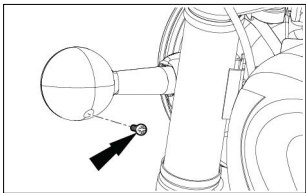

- Remove the lens cover from trafficator assembly.

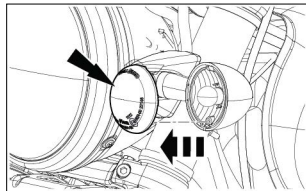

- Gently press and turn it anti clockwise to remove bulb from holder.

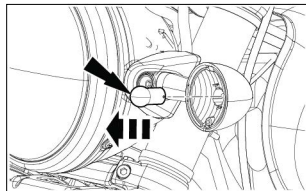

MINOR MAINTENANCE TIPS

TRAFFICATOR BULB ASSEMBLY

- Gently press and turn it clockwise to fix the bulb into holder.

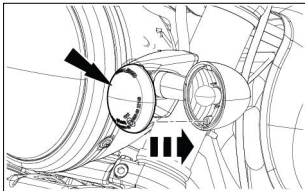

- Locate lens cover into trafficator assembly.

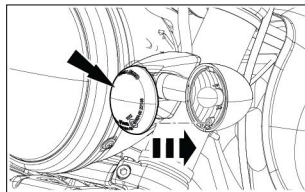

- Tighten screw into trafficator assembly.

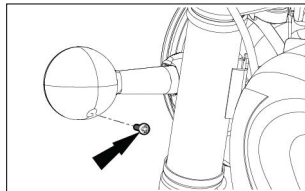

MINOR MAINTENANCE TIPS

HEAD LIGHT BEAM ADJUSTMENT

- The headlight beam focus can be adjusted in vertical direction by using the adjusting screw by turning clockwise or anti clockwise direction.
- The adjusting screw is used to increase or decrease the height of the headlight beam in vertical direction only. This may be required to increase the visibility and to help prevent blinding the other riders/vehicles passing nearby.

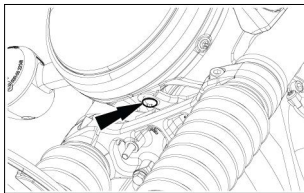

MINOR MAINTENANCE TIPS

FUSE AND FUSE CARRIER

- The fuse carrier is located inside the right side panel.
- Insert ignition key and turn it clockwise.
- Pull the side panel out to open the fuse carrier.

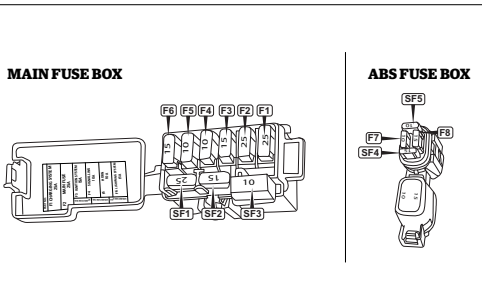
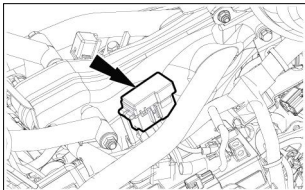

MINOR MAINTENANCE TIPS

MINI BLADE FUSE USAGE LIST

Fuse ID number	Color	Rating	Remarks
F1	WHT	25A	Charging system
F2	WHT	25A	Main fuse
F3	BLU	15A	Ignition system
F4	RED	10A	Signalling
F5	RED	10A	Horn
F6	BLU	15A	Lighting system
ABS fuse list			
F7	RED	10A	ABS fuse-1
F8	BLU	15A	ABS fuse-2
Spare fuse list			
SF1	WHT	25A	Spare fuse
SF2	BLU	15A	
SF3	RED	10A	
SF4	BLU	15A	
SF5	RED	10A	



WARNING

Please get the electrical system of your motorcycle checked thoroughly and get the faults corrected immediately after experiencing any fuse failure. Failure to do so may result in repeated fuse failure.

Usage of fuses other than specified rating or usage of any other conductive materials or low grade fuses will damage the complete electrical system.

Please ensure to replace a spare fuse in the holder at the earliest opportunity.

Any attempt to jump a defective fuse gives rise to the risk of a short-circuit and fire. Always replace a defective fuse with a new fuse of the same rating.

NOTE

Make sure the ignition switch is in "OFF" position when replacing the bulbs, fuses and electrical parts.

MINOR MAINTENANCE TIPS

AIR FILTER

- The air filter is located inside the left side panel.
- Turn key clockwise to unlock the left side panel.
- Slide downwards and upwards to remove the document holder.
- Remove the air filter cover screws x 3 by using screw driver available in the tool kit.

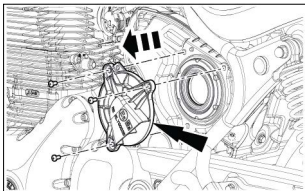

- Take out the cover from air filter box.

- Pull out filter element and check for dirt. Clean filter element carefully.

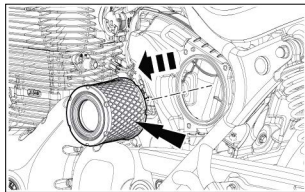

- Check for dust, oil particles inside air filter box and clean carefully.

NOTE

Usage of high pressure compressed air is not recommended to clean air filter element. To replace the air filter element, follow the removal process in reverse order.

LONG TRIP PRECAUTIONS

CHECKS PRIOR TO THE COMMENCEMENT OF A LONG JOURNEY

- Service the motorcycle at Royal Enfield Authorised Service Centre.
- Ensure sufficient quantity of fuel is always available in the fuel tank for the journey planned.
- Check and correct tyre pressure if necessary.

CHECK ALL OF THESE ASPECTS BEFORE LONG RIDE

- Any loose fasteners.
- Condition of the tyres.
- Correct oil level in engine.
- Working of all lights and horn.
- Proper drive chain tension.
- Clutch cable free play.

ITEMS TO BE CARRIED

- Tool kit.
- Fuse.
- Accelerator and clutch cables.
- Spark plug, spark plug cap and fuel hose.

REAR SUSPENSION SETTING

- Rest the motorcycle on center stand.
- Ensure the tyre pressure is at recommended specification.
- Ensure adjuster are clear of all dirt and debris before adjusting, if they have dirt or debris please clean it suitably before adjusting.

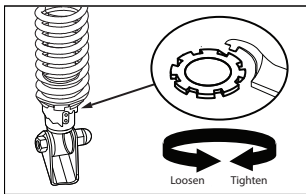

- The adjuster is a 6 step adjuster and it is kept at first notch position.

- Adjust shock preload by rotating the adjuster clockwise using C-spanner to increase the preload.
- Adjust shock preload by rotating anti-clockwise using C-spanner to decrease preload (to make it to first notch position).
- Make the same adjustments on both sides, uneven adjustment may lead to discomfort for the rider.

NOTE

- Adjusting the suspension requires a C-spanner. It is we recommend to use the C-spanner that is given in your vehicle tool kit. Extension tube to be used for leverage purposes.
- The best spring preload setting is achieved when it is set for the weight of the rider and that of any luggage and a passenger.

REAR SUSPENSION SETTING

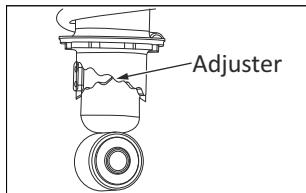

- We recommend to increase the preload and keep it at final notch for fully loaded (GVW condition), thus ensuring an ideal compromise between handling and stability.

Condition	Max reference payload	Suspension setting notch	Tyre pressure (psi)	
			Front	Rear
Unladen / One up loading / Rider only	Rider up to 90 kg	1 st	29	32
Laden / Two up / Rider + Pillion / Rider + Pillion + Accessories	Up to a maximum of 180 kg payload (Inc of rider weight, pillion weight and accessories)	6 th	29	36

* Ensure the preload is set equally on the LH and RH rear suspension.

CLEANING PROCEDURE

PRECAUTIONS

- Remove ignition key and seal the ignition key barrel slot using adhesive tape.
- Please remove tool kit, first aid kit and other relevant documents if any inside the right side panel before proceeding for washing of the motorcycle.
- Cover the silencer tail pipe, horn and control switches with suitable plastic bags and tie if firmly to prevent water entry.
- Wash the motorcycle only when the engine is in cold condition.
- Do not remove side panels while washing to avoid water entry.
- Brush engine area with a recommend non corrosive solvent to remove dirt or grease.
- Use low pressure water jet to clean.
- Never spray water with great force on head lamp, meter / cluster unit, flasher lights, front and rear wheel hubs, electrical connections and wires, control cables, EFI components, spark plug, battery, side panels.
- Do not use high pressure washers or steam jet cleaners near the seal of headstock bearing or steering stem bearing, seal of wheel bearing, brake calipers, air intakes & exhaust outlets.
- Do not apply any corrosive solvent on painted surfaces or rubber parts.
- Use lukewarm water and mild detergent on the painted components to remove dirt, etc.
- Clean motorcycle thoroughly with plain water to remove the detergent.
- Never spray water towards bottom side of instrument cluster directly to avoid water entry through breather holes.
- If possible, use compressed air and blow off water particles from the obscure areas of the motorcycle, electrical connections etc.

CLEANING PROCEDURE

- Once the motorcycle has been ridden in salty conditions (i.e. during winter in places where road salt is used) or near coastal areas it is recommended to clean your motorcycle with cold water after the ride to prevent corrosion or rust build-up. Please do not use warm water for washing as it may damage the motorcycle due to chemical reaction with the salt. After washing process once the motorcycle is completely dry it is recommended to apply anti corrosion spray on all the metal and chrome plated areas to protect the parts from corrosion.
- It is recommended not to apply the anti-corrosion spray on the brake discs.
- Do not use petrol, brake oil or other flammable liquids to clean or wash on electronic parts.
- The parts chosen using motorcycle configurator should not be washed with soap or chemical, use only plain water.
- No direct jet at the edges of decal, electrical parts, coupler joints, silencer tail pipe, radiator lubrication points

like steering cone kit, brake pedal, wheel bearings, chain, brake cam & swing arm bushes to be washed in spray mode only (not in jet mode).

AFTER WASHING

- Ensure, the motorcycle is thoroughly dry by wiping with a clean soft lint free absorbent cloth or chamois leather.
- Remove all adhesive tapes.
- Lubricate control cables, pivots for footrest, side stand, brake and gear shifter linkages, drive chain etc., with lube oil.
- Polish the painted and plated surfaces using recommended automobile polishing wax.
- Start the engine and allow to run at an idling speed for a few minutes to warm up engine.
- Drive the motorcycle slowly, apply both the brakes intermittently to dry up the water in brake pads.
- Please clean / wipe out water spoils completely inside the RH side panel before keeping tool kit and other relevant documents inside the right side panel.

STORAGE PRECAUTIONS

If your motorcycle is not going to be used for a month or more, the following precautions should be taken.

- Get the motorcycle serviced through a Royal Enfield Authorised Service Centre.
- Drain the fuel completely from the fuel tank and induction system.
- Remove spark plug and pour in about 5 ml of clean engine oil through spark plug hole. Close the hole and crank engine several times and refit spark plug.
- Clean drive chain thoroughly and apply Royal Enfield recommended chain lubricant.
- Wipe off excess lubricant after 5 minutes of application.
- Remove charging circuit fuse from the fuse box.
- Store the battery in a cool, dry and well ventilated place.
- Cover the silencer with suitable bags to prevent moisture entry. Set the motorcycle on its center stand.
- Apply anti rust solutions on all plated parts. Take care not to apply this solution on chrome, rubber or painted parts. Store motorcycle in a clean covered area free of moisture and dust.
- For re-use after storage, it is preferable to get the motorcycle prepared through a Royal Enfield Authorised Service Centre to ensure the motorcycle is restored to its peak operating conditions.
- If the motorcycle is not used for a month or longer, it is advised to disconnect battery terminals and remove the battery. Before refitting the battery in the motorcycle, check the battery voltage is within specification; if not, recharge it from authorised service workshop/battery dealer.

TROUBLESHOOTING

We have listed below a few basic checks in case your motorcycle is not functioning. If the problem is not rectified after these checks, it is necessary to get the motorcycle checked by a Royal Enfield Authorised Dealer/ Service Centre to rectify the problem and to ensure trouble free performance.

Symptom	Observations	Check for/Remedy
Engine does not start	If the ignition/Engine kill switch in OFF position	Switch ON ignition
	If inadequate fuel level in fuel tank	Top up the fuel
	If the lights are dim/weak horn sound	Weak or discharged battery / problem in charging circuit; Contact Authorised service center
	If fuse is blown	1. Replace the fuse with same rating 2. Contact Authorised service center if problem persists
	Connection issue with spark plug, cap, high tension cable	Reconnect spark plug, cap and high tension cable.

TROUBLESHOOTING

Symptom	Observations	Check for/Remedy
Engine starts but shuts off immediately	If the MIL lamp in cluster is glowing	Contact Authorised service center
Engine mis-fires & runs erratically/ stops.	If any adulteration/water in fuel	Contact Authorised service center
	If the engine is too hot	Switch OFF the engine and allow it to cool down
Poor pickup	If engine RPM raises disproportionately to the vehicle speed	Adjust the clutch free play and contact Authorised service center
ABS (Anti - lock Braking System)	If the ABS lamp continuously ON	Contact Authorised service center

ENVIRONMENT CARE

BE AN ENVIRONMENTALLY CONSCIOUS RIDER

You've ridden through some beautiful places on your Royal Enfield. Won't you like to keep them that way? Here are some tips to help you keep those places unspoilt so that others can enjoy them too:

DISPOSAL OF END OF LIFE - PARTS / VEHICLE

While your liquid waste like engine oil, coolant and other cleaning solvents need to be regularly replaced, what happens to them? Make sure they are not dumped in the soil or water bodies.

You should store them in a container and handover to a Govt authorised recycling agent, if any, or RE Service Centre.

In the case of battery, tyres, plastic parts, electric or electronic parts and oil filter, they should be handed over only to an authorized recycling agent, if any, or RE Service Centre.

The cleaning solvents or sprays used for cleaning your bike should be disposed in an environmentally friendly manner.

In case you want to dispose your vehicle when it is considered as an end of life vehicle, please handover the vehicle only to an authorized / registered vehicle scrapping facility near you or contact local authorities to follow due process.

PERIODICAL MAINTENANCE

The maintenance schedule detailed here will help you to maintain your HNTR 350 motorcycle meticulously to get a long, trouble-free service. The schedule provided herein is based upon average riding conditions and indicates the km at which regular inspections, adjustments, replacements and lubrications are to be carried out. The frequency of the maintenance must be shortened depending upon the severity of the driving condition or if the motorcycle is used in a very dusty environment. Contact the nearest Royal Enfield Authorised Service Centre for expert advice and to carry out the required maintenance.

S.No	DESCRIPTION	PERIODICAL MAINTENANCE (Whichever is earlier)										
		0.5	5	10	15	20	25	30	35	40	45	50
	km (x 1,000)	0.3	3	6	9	12	15	18	21	24	27	30
	Miles (x 1,000)	1.5	6	12	18	24	30	36	42	48	54	60
	Months	R	I	R	I	R	I	R	I	R	I	R
1	Engine oil (Level check/replace)	Check level at every 1,000 km or earlier and top up as required										
2	Engine oil filter element	R		R		R		R		R		R
3	Engine oil strainer on crankcase LH	C		C		C		C		C		C
4	Inlet/exhaust tappet setting			I&A		I&A		I&A		I&A		I&A
5	Rubber hose-intake adapter	I	I	I	I	I	I	I	I	I	I	I

PERIODICAL MAINTENANCE

S.No	DESCRIPTION	PERIODICAL MAINTENANCE (Whichever is earlier)										
		0.5	5	10	15	20	25	30	35	40	45	50
	km (x 1,000)	0.3	3	6	9	12	15	18	21	24	27	30
	Miles (x 1,000)	1.5	6	12	18	24	30	36	42	48	54	60
	Months											
6	Evaporative emission equipment rubber hoses & drain the overfilled hoses by removing plug	I	I	I	I	I	I	I	I	R	I	I
7	Spark plug			C&A		R		C&A		R		C&A
8	HT lead for crack	I	I	I	I	I	I	I	I	I	I	I
9	Air filter element	C	C	R	C	R	C	R	C	R	C	R
		Clean / Replace more frequently if operated in dusty condition										
10	Vent pipe under air filter box	I	I	I	I	I	I	I	I	I	I	I
11	Starter motor & starter relay connection	I	I	I	I	I	I	I	I	I	I	I
12	Battery terminals (apply petroleum jelly)	C	C	C	C	C	C	C	C	C	C	C

PERIODICAL MAINTENANCE

S.No	DESCRIPTION	PERIODICAL MAINTENANCE (Whichever is earlier)										
		0.5	5	10	15	20	25	30	35	40	45	50
	km (x 1,000)	0.3	3	6	9	12	15	18	21	24	27	30
	Miles (x 1,000)	1.5	6	12	18	24	30	36	42	48	54	60
	Months											
13	Earth wire eyelet contact											
14	Injector hose											
15	Fuel filter in fuel pump							R				
16	Front fork oil					R				R		
17	Steering ball races play	Inspect & adjust, if required lubricate for every 5,000 km or earlier as required. Replace if necessary										
18	Spokes tightness/wheel rim run out front & rear											
19	Swing arm pivot bush & spacer		Inspect & if required lubricate for every 5,000 km or earlier as required. Replace if necessary									
20	Tyre wear pattern (front & rear)											
21	Rear wheel cush drive rubbers					I&R				I&R		

PERIODICAL MAINTENANCE

S.No	DESCRIPTION	PERIODICAL MAINTENANCE (Whichever is earlier)										
		km (x 1,000)	0.5	5	10	15	20	25	30	35	40	45
	Miles (x 1,000)	0.3	3	6	9	12	15	18	21	24	27	30
	Months	1.5	6	12	18	24	30	36	42	48	54	60
22	Rear wheel drive chain	Clean, lubricate every 500 km / clean, lubricate & adjust every 5,000 km or earlier as required										
23	Front & rear brake hose & banjo bolt	I	I	I	I	I	I	I	I	I	I	I
24	Brake fluid level, front & rear disc	I	I	I	I	R	I	I	I	R	I	I
25	Clutch lever / cable free play	Adjust every 1,000 km or earlier as required & replace if required.										
26	Hand levers & foot levers	Lubricate every 1,000 km or earlier as required.										
27	Throttle cable	Adjust every 5,000 km or earlier if required										
28	Brake pads - front & rear	I	I	I	I	I	I	I	I	I	I	I
29	Pivot side stand, center stand, pillion foot rest, gear shifter, brake pedal, levers	L	L	L	L	L	L	L	L	L	L	L

PERIODICAL MAINTENANCE

S.No	DESCRIPTION	PERIODICAL MAINTENANCE (Whichever is earlier)										
		0.5	5	10	15	20	25	30	35	40	45	50
	km (x 1,000)	0.3	3	6	9	12	15	18	21	24	27	30
	Miles (x 1,000)	1.5	6	12	18	24	30	36	42	48	54	60
	Months											
30	Side stand switch operation	I	I	I	I	I	I	I	I	I	I	I
31	All mounting fasteners in vehicle for tightness	I	I	I	I	I	I	I	I	I	I	I
32	Throttle body - cleaning	Throttle body should be removed from the vehicle and cleaned with a dry microfibre cloth, usage of throttle body cleaners or any similar solvent or alcohol based liquids for cleaning is strictly prohibited, Throttle body cleaning every 10,000 km / 12 months or earlier as required.										

A : Adjust C : Clean I : Inspect (Clean, Adjust, Lubricate or replace if necessary) L : Lubricate R : Replace

NOTE

For maintenance after 50,000 km, please repeat at the same frequency level specified above, in consultation with a Royal Enfield Authorised Dealer / Service Centre.

GENERAL WARRANTY TERMS AND CONDITIONS

Royal Enfield motorcycles ("Motorcycles") are manufactured by following best quality practices in respect of the material and workmanship. All motorcycles (irrespective of their country of registration) can avail limited warranty services from a Royal Enfield Authorised Dealer Workshop / Service Centre located in another country, in addition to its country of registration; and customers should refer to the terms and conditions mentioned under Borderless Warranty Policy.

IMPORTANT: Please make sure you have read and understood these terms and conditions

This warranty outlines the terms and conditions governing the Motorcycles warranty coverage obligations and exclusions only and not on the part of any Royal Enfield Authorised Dealer. Nothing in this document should be construed as a principle agent relationship between Royal Enfield and any of its Authorised Dealers or their staff. Royal Enfield warrants its Motorcycles to be free from manufacturing and material defects under normal use subject to the following conditions:

1. Warranty for any Motorcycle shall be in force until the expiry of a period of 36 months from the date of the Sale of the motorcycle to the first owner and to any subsequent owners for the balance of the remaining period until the expiry of above mentioned warranty period.
2. In order to avail warranty benefits by second or subsequent owner, the second or subsequent owner should inform the nearest Royal Enfield Service Centre about the purchase of the motorcycle and shall fill in the requisite details in the form as requested by Authorized Royal Enfield Service Centre.

GENERAL WARRANTY TERMS AND CONDITIONS

3. The warranty on any Motorcycle shall be applicable only if all the maintenance and services with respect to the said Motorcycle are performed by the owner(s) within the respective Warranty Period/kilometer ranges as per the schedule in the owner's manual from Royal Enfield Authorized Dealer/Service Centre.
4. During the warranty term, Royal Enfield's warranty obligations shall be limited only to repair or replace the faulty part(s) with a new part(s) only if such faulty part(s) on examination is deemed to have a manufacturing defect. Defective part(s) which have been replaced under the Warranty term shall become the sole property of Royal Enfield.
5. This warranty is expressly limited to the repair or replacement of the genuine parts with a manufacturing defect and is the sole remedy of warranty.
6. To the fullest extent permissible by applicable law, all other warranties of any kind, either express or implied, are disclaimed. The exclusion of implied warranties mentioned herein does not apply to the extent prohibited by any applicable law.
7. Warranty shall not apply to:
 - (a) Consumables including but not limited to oil, oil filter, brake fluid, coolant, fuel, grease etc. used during repair/replacement are not covered and such consumables shall be chargeable to the customer.

GENERAL WARRANTY TERMS AND CONDITIONS

- (b) The customer assumes all the risk and liability arising out of his or her repairs to the Product or replacement parts thereto or arising out of his or her installation of replacement parts thereto. If at any time during the warranty period, the Product or any part or parts thereof are removed, altered, tampered, adjusted, modified, dismantled, repaired or handled in any way whatsoever by any person or persons not authorized by the Company, this Policy shall immediately cease to be valid and become void initially and of no effect whatsoever.
- (c) Normal ageing (wear and tear), deterioration or rusting of plated parts, paints coat, rubber parts, soft items, glass items, plastic parts etc. Components like oil filter, air filter paper element, control cables, brake shoes/brake pads, clutch plates, drive chain & sprocket kit, steering ball races, electrical equipment, wiring harness etc., which are subjected to normal wear and tear. Failures occurred due to use of non-recommended grade lubricants, coolant, brake fluid, fork oil, fuel or improper level.
- (d) Damages due to use of non-genuine parts or accessories, lack of proper maintenance, incorrect riding habits. Damages to engine management system parts (like ECU, throttle body, sensors, etc.) due to tampering which affects the performance of the motorcycle. Parts damaged due to accidents, collision, neglect, abuse, mishandling, fire or any act of God etc.
- (e) Irregularities not recognised as affecting the quality or function of the motorcycle such as slight vibration, oil leakage, discoloration of exhaust pipe bend and cat region/silencer/soft or hard shock absorber etc.

GENERAL WARRANTY TERMS AND CONDITIONS

- (f) Discoloration of exhaust pipe & silencer, as it is a natural process that will happen during usage.
- (g) Defects or damage arising from fitment of unauthorised accessories or parts like side cars, trailer hitches etc., or additional electrical loads.
- (h) Motorcycle serviced or repaired at unauthorised service centres.
- (i) Motorcycle used for competitions/racing/stage rallying/stunts/jumping/acrobatics etc. or similar activities as Motorcycles are not designed or intended for such purpose or usage.
- (j) Electrical component like bulbs, fuses etc., and electronic components failure including ECU due to repairs by arc welding.
- (k) Motorcycle found with tampering/drilling/welding mark on any part of the frame.
- (l) Normal maintenance operations like adjustment of brakes, cleaning fuel system, engine tune-up and other such adjustments.
- (m) Oxidization of buffed/painted/powder coated items etc
- (n) Any damage resulting due to any force majeure event including, without limitation, any act of war, act of God or nature, earthquake, hurricanes, tornadoes, flood, fire or other similar casualty, riot, terrorism etc.
- (o) Any damage, failure or loss caused by improper assembly, maintenance, storage or use of the motorcycle or parts thereof.

GENERAL WARRANTY TERMS AND CONDITIONS

8. Use only Royal Enfield approved parts and accessories (as applicable). Use of other manufacturer's performance parts will void your motorcycle warranty.
9. The warranty will be null and void if
 - (a) The Motorcycle is used in a manner other than for recreation or transportation; or
 - (b) The Motorcycle is modified in any manner; or
 - (c) The serial number /identification code is deleted, defaced, altered, effaced or removed.
10. The following are specifically excluded from the terms and provisions of this warranty:
 - (a) Labour costs for fitting replacement parts under this warranty unless the original warranted part or accessory was fitted by any Royal Enfield Authorised Dealer.
 - (b) Any RE accessory modified for use or installed on a RE Motorcycle model for which it is not designed or recommended.
11. Royal Enfield reserves the right to finally decide on all warranty claims.
12. RE reserves the right to make changes in the design of the motorcycle models without any obligation to install these changes on previously supplied Motorcycles.

GENERAL WARRANTY TERMS AND CONDITIONS

13. Royal Enfield may, as a result of the purchase of motorcycle/ its parts and prescribed accessories/ servicing of motorcycles/ claiming of any applicable warranty during the Warranty Period by you (i.e., customer), receive sensitive and/or personal data and information relating to you or third parties associated with you (such as your spouse or family members, or relatives). Such data may be received from you, or from other sources, and some sensitive/personal data may be recorded directly or indirectly by internal security systems of Royal Enfield or by other means. Royal Enfield may process such data for relevant and limited purposes and in this regard, you expressly consent to the following:
- (a) The processing of sensitive personal data and information pertaining to you or the third parties associated with you, by Royal Enfield.
 - (b) The collection and processing of sensitive personal data and information about you for limited purposes.
 - (c) The worldwide transfer of sensitive personal data and information pertaining to you or the third parties associated with you, held by Royal Enfield, to its service providers, dealers, suppliers, advisors and offices of Royal Enfield's worldwide organization and to third parties where disclosure to such third parties is required in the normal course of business or by law; and use of the your personal images and voices in marketing material, videos, etc.

GENERAL WARRANTY TERMS AND CONDITIONS

In the event you wish to withdraw the express consent provided in point 13 above, you agree to send an email to support@royalenfield.com specifying that you wish to withdraw such consent and RE shall accordingly delete all the sensitive and/or personal data pertaining to you, as available in the records of RE within a reasonable time, in accordance with applicable laws.

14. The exclusive remedy for breach of this warranty shall be, at Royal Enfield's option, repair or replacement of any defective materials, components, or products. The remedies set forth in this warranty are the only remedies available to any person for breach of this warranty. RE shall have no liability to any person for incidental, consequential or special damages of any description, whether arising out of express or implied warranty or any other contract, negligence, or other tort or otherwise. This exclusion of consequential, incidental, and special damages is independent from and shall survive any finding that the exclusive remedy failed of its essential purpose.
15. Disclaimer of Warranties: Except for warranties expressly made herein, RE makes no warranties or representations express or implied, either in fact or by operation of law, statutory or otherwise.
16. The General Warranty shall be governed by the laws of India and you hereby consent to the exclusive jurisdiction and venue of courts in New Delhi, India.

BORDERLESS WARRANTY TERMS AND CONDITIONS

RE Borderless Warranty (not applicable for motorcycles exported from one country to another under personal imports) is subject to following conditions.



1. The rider should carry maintenance and service records, proof of ownership and Motorcycle registration document (original / photocopy / soft copy) for verification by the Royal Enfield Authorized Dealer.
2. The periodic maintenance services have been performed in the respective period/kilometer ranges as per the schedule in the owner's manual from a Royal Enfield Authorized Dealer Workshop/Service Centre.
3. Royal Enfield Authorized Dealer Workshop's / Service Centre's obligations shall be limited to repairing/replacing the genuine part(s) of the motorcycle free of cost only if the part(s), on examination, is deemed to have a manufacturing defect. Defective part(s) which have been replaced will become the sole property of Royal Enfield after due verification.
4. The rider shall transport the motorcycle to/from a Royal Enfield Authorized Dealer Workshop / Service Centre on his own cost and means.

BORDERLESS WARRANTY TERMS AND CONDITIONS

5. Royal Enfield Authorized Dealer Workshop / Service Centre shall work towards delivering the motorcycle at the best possible time. However, servicing time /period may be longer than usual / extended subject to the availability of required emission / country specific homologated spare parts in the given country.
6. Royal Enfield Authorized Dealer Workshop / Service Centre shall take utmost care with disassembly and reassembly or removal and refitment of non-genuine spare parts and accessories including electrical or electronics items like fog lamps, high power lamps, aftermarket horns, mobile phone charger, navigator etc. However, the Royal Enfield Authorized Dealer Workshop / Service Center shall not take responsibility for any breakage / damage / malfunction / inability to refit due to non-availability of special tools / skills etc for assembling the non-genuine spare parts and/or accessories while servicing / repairing the motorcycle.
7. Neither RE nor any Royal Enfield Authorised Dealers and / or its distributors shall be held liable for any loss including loss of time / money due to delay in servicing / repairing the motorcycle and the rider is responsible to make his own arrangement for accommodation, further travel etc in such cases.
8. In the event the motorcycle is required to be towed to another workshop for further repair or to the rider's home country as repatriation, it shall be done at the rider's own expenses and risk.
9. The remaining Terms and Conditions shall be the same as for General Warranty.
10. The Borderless Warranty shall be governed by the laws of India and you hereby consent to the exclusive jurisdiction and venue of courts in New Delhi, India.

For updated Authorized Service network, visit <https://www.royalenfield.com/in/en/locate-us/service-centres>.

If you are traveling abroad and require warranty assistance or advice from a Royal Enfield Authorized Dealer, visit www.royalenfield.com/borderless-warranty/ for more information.

CUSTOMER'S RESPONSIBILITY

1. The customer shall take all possible steps to prevent further damage as soon as any problem is apparent and within a reasonable time from such damage, notify Royal Enfield Authorized Dealer / Service Centre of such damage.
2. By purchasing any Motorcycle produced by RE, the customer assumes responsibility to ascertain and follow all applicable laws, and international laws in having, owning, using, or transporting any Motorcycle. The customer expressly agrees to indemnify and hold harmless RE for all claims resulting directly or indirectly from the purchase, ownership, transportation, or use of the Motorcycle in violation of applicable laws. RE is not liable for misuse of any Motorcycle purchased from an authorised Dealer / Distributor.

LIMITATION OF LIABILITY

Notwithstanding anything contrary contained in this policy, Royal Enfield's liability under this warranty is limited to the repair of the defective Motorcycle, at its sole discretion. In no event shall Royal Enfield be liable for any indirect, special or consequential or incidental damages or for injury to person or property, or for loss of time or for any commercial loss, or inconvenience or any other incidental or punitive or consequential loss arising from the use of Motorcycles.

EMISSION CONTROL SYSTEM WARRANTY

Royal Enfield certifies that the following warranty is applicable to those components liable to affect the emission of the gaseous pollutants in its range of motorcycle, in normal use to which it may be subjected to.

This emission warranty is valid for 30,000 km/3 years from the date of first sale, whichever is earlier, to the first customer and is in addition to and parallel to the warranty policy, conditions and obligations laid down in the Owner's Manual.

Royal Enfield further warrants that if on examination by its Royal Enfield Authorised Service Centre, the motorcycle fails to meet the specified emission standards, then the Authorised Service Centre shall take necessary corrective measures and shall, at its sole discretion, repair or replace free of charge components of the emission control system to meet the required emission standards.

The method/s of examination to determine the warranty conditions of the emission warranty related components will be at the sole discretion of Royal Enfield and/or our Authorised Service Centre and results of such examination will be final and binding. If on examination the warranty conditions of the part/s is/are not established, Royal Enfield will have the right to charge all, or part of the cost of such examination to the customer in addition to the cost of the components.

In case of acceptance of the component/s under Emission warranty, Royal Enfield will replace free of charge the component/s as required. However, the consumables like fuel, lubricants, solvents, etc. shall be chargeable to the customer as per actuals.

EMISSION CONTROL SYSTEM WARRANTY

If any of the components covered under emission warranty or the associated parts are not independently replaceable, Royal Enfield will have the sole discretion to replace either the entire assembly or parts of the assembly through suitable repairs.

Royal Enfield reserves the right to carry out necessary consequential repairs to the motorcycle or replace any part, in addition to the repair or replacement of the components covered under emission warranty, to establish compliance to in use emission standards. Such repairs/replacements will be chargeable to the customer.

All parts removed for replacement under warranty will become the property of Royal Enfield.

Royal Enfield will not be responsible for the cost of transportation of the motorcycle to the nearest Authorised Service Centre or for any loss due to non availability of the motorcycle during the period of examination and repairs by Royal Enfield and/or their Authorised Service Centre.

Royal Enfield will not be responsible for any penalties that may be charged by statutory authorities on account of failure to comply with the current emission standards.

The cost incurred to check emission of the motorcycle will have to be borne by the customer.

Emission warranty will be applicable irrespective of the change of ownership of the motorcycle, provided all the conditions as laid down in this document are met from the date of original sale of the motorcycle.

EMISSION CONTROL SYSTEM WARRANTY

THE WARRANTY SHALL APPLY IF THE CUSTOMER

- Observes all the important instructions and any other precautions listed in the owner's manual.
- Under all circumstances uses lubricants and fuel as recommended by Royal Enfield.
- Regularly obtains and carries out maintenance in accordance with Royal Enfield guidelines and enters the details in the log book.
- Immediately approaches the nearest RE Authorised Dealer / Service Centre upon discovery of failure to comply with the emission standard in spite of having maintained and used the motorcycle in accordance with the instructions in the owner's manual and having carried out such repairs and adjustments as may be required with a view to establish such compliance.
- Produces a valid pollution under control certificate, as necessary to claim emission warranty.
- Produces the owner's manual and log book for verification details.
- Produces receipts covering maintenance of the motorcycle, as specified in the owner's manual from the date of original purchase of the motorcycle.
- Produces valid certificate of Insurance and RTO Registration Certificate (R.C. Book).

EMISSION CONTROL SYSTEM WARRANTY

THE EMISSION WARRANTY SHALL NOT APPLY IF

- A valid "Pollution under control" certificate is not produced.
- The motorcycle is not serviced by RE Authorised Dealer / Service Centre as per the service schedule described in the maintenance chart.
- The motorcycle has been subjected to abnormal use, abuse, neglect and improper maintenance or has met with an accident.
- Replacement parts not specified and approved by Royal Enfield have been used.
- The motorcycle, or parts thereof, has been altered, tampered with or modified or replaced in an unauthorised manner.
- The odometer is not functioning or the odometer and / or its reading has been changed / tampered with, so that the actual distance covered cannot be readily determined.
- The motorcycle has been used for competitions, races and rallies or for the purpose of establishing records.
- On examination by Royal Enfield or its Authorised Dealer / Service Centre, if the motorcycle shows that any of the conditions stipulated in the owner's manual with regard to use and maintenance have been violated.
- The motorcycle has been run on adulterated / leaded fuel or lubricant other than those specified by Royal Enfield in the owner's manual or any other document given to the customer at the time of sale of the motorcycle.

EMISSION CONTROL SYSTEM WARRANTY

- The emission related components are tampered with.
- All service and parts related bills and vouchers incurred during the tenure of the emission warranty are not produced.
- All maintenance activities carried out on the motorcycle during the tenure of the emission warranty are not entered in the log book.

TIPS TO BE ON THE RIGHT SIDE OF LAW

- Always get your motorcycle checked to meet the emission regulations through an authorised emission checking centre.
- Always carry a valid "Pollution Under Control" certificate with you, as and if applicable by law.

TIPS TO REDUCE POLLUTION

- Ensure that the periodical maintenance is carried out as stipulated in the owner's manual through a Royal Enfield Authorised Service Centre.
- Use only unleaded petrol (91 RON or higher) from reputed fuel pumps.
- Ensure the fuel used is not adulterated.
- Use correct spark plug as recommended in the owner's manual.
- Use lubricants as per recommendations given on grade / brand in the owner's manual.

EVAPORATIVE EMISSION CONTROL SYSTEM WARRANTY

The following warranty applies to the evaporative emission control system.

Royal Enfield motors warrants the first owner and each subsequent owner that this motorcycle is designed and built so as to conform, at the time of sale, with applicable regulations specified for the evaporative emission control system warranty. Related parts fitted to this motorcycle are free from defects in materials and workmanship which may cause this motorcycle not to meet applicable regulations for a period of 24 months from the date of first use of the motorcycle.

The Warranty period shall begin either on the date the motorcycle is delivered to the first retail purchaser or from the first date the motorcycle is used as a demonstrator or as a display and / or trial motorcycle.

THE FOLLOWING ARE NOT COVERED BY THE EVAPORATIVE EMISSION CONTROL SYSTEM WARRANTY

1. Failures which may arise as a result of misuse, alterations, accidents or non performance of routine maintenance, as specified in the owner's manual.
2. Replacing, removing or modifying any portion of the Evaporative Emission Control System (consisting of fuel tank, fuel tank cap, canister, purge valve, throttle body, vapor hoses, fuel hoses and hose connectors) with parts not certified by Royal Enfield.
3. Loss of time, inconvenience, loss of motorcycle use or any other consequential loss or damages.
4. Any motorcycle in which the odometer has been tampered with or the speedo cable has been disconnected for any reason or is broken and not replaced immediately, due to which the exact distance covered cannot be determined.
5. Normal aging of parts such as fuel hoses, vapor hoses, gaskets and rubber components.

RECOMMENDATIONS FOR REQUIRED MAINTENANCE

It is recommended that the routine maintenance of the motorcycle be carried out at specified intervals and any maintenance to the evaporative emission control systems should be performed only by an Authorised Royal Enfield Service Centre and using only genuine Royal Enfield spare parts.

RADIO TYPE APPROVAL

TRIPPER/NAVIGATION DISPLAY UNIT

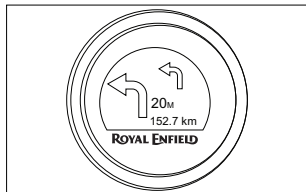

UNITED KINGDOM (UK)



EUROPEAN UNION (EU)



Max. RF power: 4 dBm and Operation frequency range:
2408 to 2480 MHz

Hereby, Visteon Corporation declares that the radio equipment type JDCP is in compliance with Directive 2014/53/EU. The full text of the EU declaration of conformity is available at the following internet address: www.visteon-docs.com.

SERVICE/MAINTENANCE RECORD

S.No	Type of service	Schedule	Date	Job card No.	km	Dealer code	Brief details of service

WIRING DIAGRAM

DISCLAIMER

It is recommended that the wiring circuit repair and any other electrical rework should be performed only by an Authorized Royal Enfield Service Centre, failure to adhere this may cause damage to electrical systems and render the warranty of the products as void.



NOTES

NOTES

NOTES

NOTES

NOTES

NOTES

NOTES

Scan the below QR code to avail the soft copy of owner's manual as per your choice of language



ROYAL ENFIELD

ROYALENFIELD.COM



Part No. RAM01203/A

Edition: 19th May 2026